



User's Manual

DuraVision® FDF2712W-IP FDF2312W-IP DX0212-IP

Software Version 6.2

Important

Please read this "User's Manual", and "PRECAUTIONS" (separate volume) carefully to familiarize yourself with safe and effective usage.

-
- For the latest product information including the "User's Manual", refer to our web site :

www.eizoglobal.com

This product has been adjusted specifically for use in the region to which it was originally shipped. If operated outside this region, the product may not perform as stated in the specifications.

No part of this manual may be reproduced, stored in a retrieval system, or transmitted, in any form or by any means, electronic, mechanical, or otherwise, without the prior written permission of EIZO Corporation. EIZO Corporation is under no obligation to hold any submitted material or information confidential unless prior arrangements are made pursuant to EIZO Corporation's receipt of said information. Although every effort has been made to ensure that this manual provides up-to-date information, please note that EIZO product specifications are subject to change without notice.

CONTENTS

CONTENTS	3		
Chapter 1 Product Overview	5		
1-1. Features	5		
1-2. User level	7		
1-3. System License.....	7		
Chapter 2 Live Image Screen / Setting			
Screen Display	9		
2-1. Displaying the Live Image Screen	9		
2-2. Displaying the Setting Screen.....	10		
● When Using the Monitor Console	10		
● When Using the Web Console.....	11		
Chapter 3 Live Image Screen Operations	12		
3-1. Switch the Live Image Screen Layout	12		
● Display in full screen	12		
● Switch the screen layout	13		
3-2. Switch the Page Displayed on the Live			
Image Screen.....	13		
● Changing pages manually.....	13		
● Switching pages automatically			
(Sequential display).....	14		
3-3. Switch to Full Screen Display With 1			
Screen Layout	14		
3-4. Switch camera image display positions ...	15		
3-5. Operating Cameras.....	16		
3-6. Playing Back Video Saved on a			
Camera's SD Card.....	18		
Chapter 4 System Settings	22		
4-1. Confirming the Basic Information	22		
4-2. Performing Network Settings.....	24		
4-3. Performing Communication Settings	25		
4-4. Setting the Date and Time	26		
4-5. Configuring the Language.....	26		
4-6. Initializing the System.....	27		
4-7. Restarting the System.....	27		
4-8. Updating Software	28		
4-9. Saving Settings Data	28		
4-10. Loading System Settings Data.....	29		
4-11. Registering a License.....	30		
4-12. Setting Event Rules	30		
4-13. Registering a Server Certificate.....	34		
4-14. Registering a Root Certificate.....	34		
4-15. Setting the Remote Control ID	35		
● Setting the product ID	35		
● Setting the remote control ID	35		
4-16. Configuring USB Device Hotkeys	36		
4-17. Setting IEEE 802.1X Authentication.....	37		
4-18. Setting the product SNMP	38		
4-19. Setting an IP Address Filter.....	40		
4-20. Setting Failover	41		
● Failover Settings.....	41		
● Camera Registration	41		
● Camera Function Settings	42		
● Display Position Settings	42		
● Overlay Settings.....	42		
● Preset Settings.....	42		
4-21. Checking Logs	43		
4-22. Saving Logs	43		
4-23. Check basic Information.....	43		
4-24. Save basic Information	43		
4-25. Performing Camera Connection			
Confirmation.....	44		
4-26. Confirming Network Connection Status...	44		
4-27. Configuring Monitor Display Settings.....	45		
4-28. Performing Other Settings	45		
4-29. Linking with a Qognify VMS	46		
4-30. Streaming Gateway Function Settings			
(DX0212-IP).....	46		
● Streaming Gateway Settings	47		
● Streaming Settings.....	48		
● Encoding Settings	48		
Chapter 5 Management of Network Cameras ...	50		
5-1. Registering a Camera Using Auto			
Discovery	50		
5-2. Registering a Camera Manually	51		
5-3. Changing Network Camera Information ...	55		
5-4. Deleting Network Cameras	55		
5-5. Importing Network Camera Information...	56		
5-6. Setting Network Camera Time	56		
5-7. Setting Quality of Transmission Video			
Images.....	57		
5-8. Registering the Network Camera Preset			
Position	59		
Chapter 6 Live Image Screen Settings	60		
6-1. Setting Display Positions of Camera			
Video Images.....	60		
6-2. Setting Display Methods of Camera			
Video Images.....	62		
6-3. Setting Custom Screen Layouts	63		
6-4. Changing the Displayed Layout Icon	64		
6-5. Setting Layout Presets.....	65		
6-6. Setting the Overlay	67		
6-7. Setting the Display Methods of Live			
Image Screens.....	69		

6-8.	Setting Current Monitor Display Status ...	69
6-9.	Checking Livestream View	70
6-10.	Updating the Camera Image of the Live Image Screen to the Latest Status.....	70
6-11.	Performing Advanced Settings for Camera Video	71
Chapter 7 Management of the User Account...		72
7-1.	Registering the User Account	72
7-2.	Changing the User Account	73
7-3.	Deleting the User Account.....	73
7-4.	Configuring Auto Login Settings	74
7-5.	Performing LDAP Settings	74
Chapter 8 Reference		76
8-1.	Installation of Optional Arm (FDF2712W- IP / FDF2312W-IP).....	76
8-2.	Connecting a Sub Monitor (FDF2712W-IP / FDF2312W-IP)	77
8-3.	Specifications	78
	● FDF2712W-IP	78
	● FDF2312W-IP	80
	● DX0212W-IP	82
8-4.	Decoding Performance	83
	● FDF2712W-IP / FDF2312W-IP	83
	● DX0212W-IP	83
8-5.	Remote Control Specifications	85
8-6.	CSV File Format for Camera Registration...	87
Appendix		88
	Trademark	88
	License	89

Chapter 1 Product Overview

This manual describes camera (network camera) settings, system settings, and product specifications.

1-1. Features

● Communication with cameras

- Possible to receive video images from a 4K camera (3840 x 2160 / 30 fps)
 - Possible to display video signals from cameras on a monitor
 - Supports H.265, H.264, and MJPEG compression formats.
 - Supports RTP, MPEG2-TS, and SRT transmission modes.
 - A maximum of 48*1 cameras can be registered.
 - Allows a free layout of video images (1 Screen, 3 Screens, 4 Screens, 9 Screens, 16 Screens, 32 Screens, 8 Screens, and Custom Screen) from multiple cameras.
 - Supports Unicast and Multicast communication methods.
 - Possible to switch the display position of camera video images while displaying video images.
 - Allows playback of videos saved on a camera's SD card.
- *1 For FDF2312W-IP, the maximum number of cameras that can be registered in the factory setting (without enterprise license registration) is 16.

● Streaming gateway function (DX0212-IP)

- "Merge mode" for streaming live image screen images
This mode converts the display of the live image screen into the RTSP or SRT protocol for streaming. By streaming multiple camera images freely laid out on the screen (live image screen) as a single stream, it reduces the network load.
- "Relay mode" for streaming individual camera images
In this mode, images received directly from each camera are streamed again without any processing using the RTSP or SRT protocol. It allows increasing the number of streams without putting additional streaming load on the cameras.

● Possible to output to monitors

- Supports FHD output to other monitors (1920 x 1080 / max. 60 fps) (FDF2712W-IP / FDF2312W-IP)
- Supports output to 4K monitors (3840 x 2160 / max. 60 fps) (DX0212-IP only)

● Supports multiple types of cameras

- Compatible with ONVIF® Profile S
- Supports camera control using camera manufacturer specific protocols
(When connecting Panasonic/i-PRO and AXIS cameras)
- Capable of receiving video streams from streaming servers such as VMS (Video Management Software)

● System management

- Possible to register cameras or set the live image screen using a Web browser
- Possible to save and load settings data
Possible to save or load the setting data onto a computer.

● **Event link function**

- **Event Rules**
You can set actions to be executed as triggers for specific events.

● **Various software extensions**

- **Icon Arranger**
Allows you to rearrange or delete live screen layout menus.
- **Livestream View**
Allows you to check the screen displayed on the main unit on a Web browser.
- **Screen orientation adjusting**
The display direction of the system output video can be rotated to match the monitor installation direction (horizontal or vertical).
- **Failover**
Allows automatic switching to a backup camera when communication with registered cameras is lost.
- **Virtual PTZ**
Even if the camera does not have PTZ functionality, this product enables PTZ operations by digitally processing the camera images internally.
- **Schedule function**
You can schedule settings such as turning on/off the system power at a specific day/time.

● **Security**

- **Comm. Error Detection**
Allows displaying of a red frame alert message on the live image screen within a few seconds when communication with cameras is lost.
- **Lock function**
Disables USB devices, front key operation, and remote control operation.
- **Network security protocols**
Supports protocols required for constructing high-level security systems including IEEE802.1X, SNMP, and LDAP.

● **Supports secure communication**

Utilizes SSL and TLS, which are secure protocols. Communication between cameras and web pages is encrypted using SSL.

Purchase an enterprise license to use LDAP authentication (refer to [“1-3. System License” \(page 7\)](#)).

● **Support**

- A 2-year long-term warranty for 24-hour continuous use

● **Operation**

- The live image screen can be controlled using a USB mouse, USB keyboard, remote control, or joystick

1-2. User level

There are three levels of user accounts that access this product. The operable range differs according to the level of the user.

- ADMIN
- CAMERA CONTROL
- LIVE

The range of operation for each level is shown below.

√: Operable, -: Inoperable

	Live Image Screen					Setting Screen
	Switch layout	Switch displayed page	Switch camera image display positions	Camera control	Playback	
ADMIN	√	√	√	√	√	√
CAMERA CONTROL	√	√	√	√	√	-
LIVE	√	-	-	-	-	-

When the power is turned on and logged off, the user level is “LIVE”. For information on user level settings, refer to [“Chapter 7 Management of the User Account” \(page 72\)](#).

In this manual, the following marks are used for operations with user level restrictions.

- Operation is only possible when the user level is “ADMIN”

User level “ADMIN”

- Operation is only possible when the user level is “ADMIN” or “CAMERA CONTROL”

There are two user levels: “ADMIN” and “CAMERA CONTROL”

1-3. System License

This product has features that can be used by applying a paid system license. The types of system licenses are as follows. For details, contact your dealer or local EIZO representative.

- Enterprise license
- SRT extended functionality license*¹
- Failover extended functionality license*¹
- Playback extended functionality license*¹
- Qognify extended functionality license*¹

*¹ This can be applied when an enterprise license is registered.

You can check the application status of the system license on the setting screen after logging in (refer to [“2-2. Displaying the Setting Screen” \(page 10\)](#)reference). For information on registering a system license, refer to [“4-11. Registering a License” \(page 30\)](#).

In this manual, the following marks are used for features that require a paid system license.

- Available only if an “Enterprise License” is applied

Enterprise license

- Available only when “SRT extended functionality license” is applied

SRT extended functionality license

- Available only when “Failover extended functionality license” is applied

Failover extended functionality license

- Available only when “Playback extended functionality license” is applied

Playback extended functionality license

- Available only when “Qognify extended functionality license” is applied

Qognify extended functionality license

Chapter 2 Live Image Screen / Setting Screen Display

2-1. Displaying the Live Image Screen

1. Press the power button (⏻) on the front of the product.

Note

- For FDF2712W-IP / FDF2312W-IP, check that the main power switch on the back is turned on.

The power indicator lights up blue and the live image screen is displayed.

Live Image Screen Layout

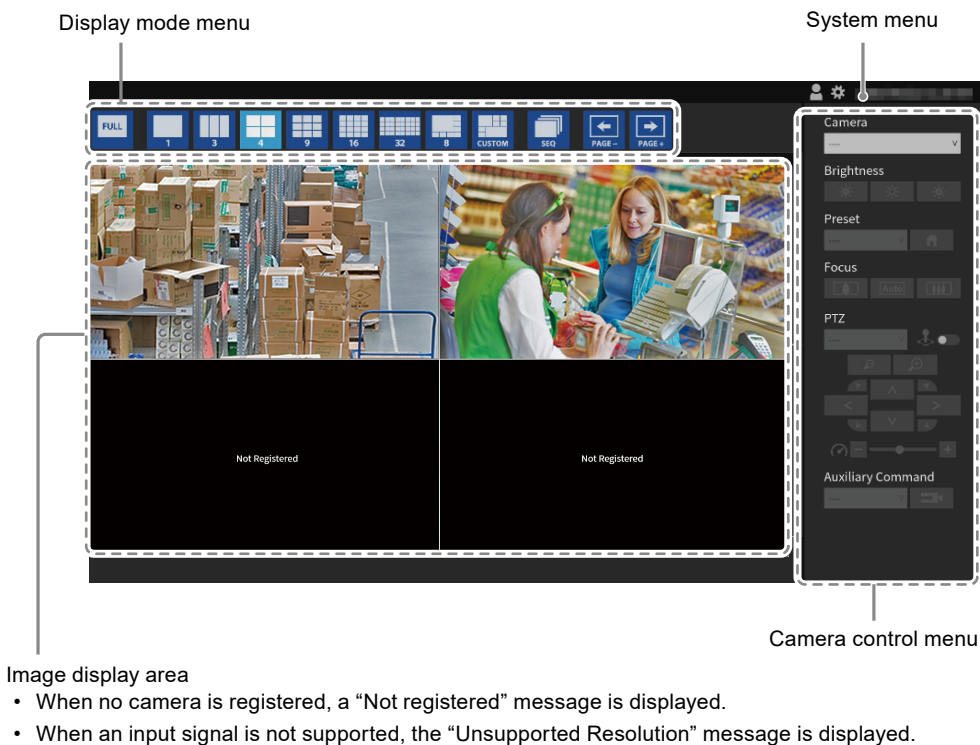

2-2. Displaying the Setting Screen

User level "ADMIN"

The setting screen can be operated using the monitor console (screen displayed on the monitor) or the web console (screen displayed on the browser).

To display the setting screen, it is necessary to log in as a user with a user level of "ADMIN".

Note

- The default settings of the user account are as follows.
 - Username: "admin"
 - Password: "admin"
 - User level: "ADMIN"
 - For information on user levels, refer to ["1-2. User level" \(page 7\)](#).
 - It is recommended that you log out after completing the setup, so as to prevent a third party from operating the camera or altering the settings.
 - When the Auto Login settings are configured, it is possible to log in to the system without the username and password (refer to ["7-4. Configuring Auto Login Settings" \(page 74\)](#)).
-

● When Using the Monitor Console

Use a USB mouse to perform operations. You cannot operate the setting screen with the remote control.

Note

- Clicking an item that requires characters to be input will display a software keyboard.
-

1. On the live image screen, click the login icon (👤).

2. Enter a username and a password.

Note

- When the "Account Type" is set to "LDAP", you can select the account type when logging in by checking "Allow choosing of account type on the login dialog" under "LDAP" in advance (refer to ["7-5. Performing LDAP Settings" \(page 74\)](#)).
-

3. Click "Login".

The setting icon (⚙️) can then be selected.

4. Click the setting icon (⚙️).

● When Using the Web Console

Use a computer connected to the network to perform operations.

Note

- Microsoft Edge 79 or later is recommended for the web browser.

1. Launch the browser.

2. Enter the following address to access the site.

Address: `http://<IP address of this product>/`

In the default settings, the IP address is `http://192.168.0.150/`.

3. Enter a username and a password.

4. Click “OK”.

The setting screen is displayed.

Note

- If you are unable to login, try using the following address. `http://<IP address of this product>/index.html`

Setting Screen Layout

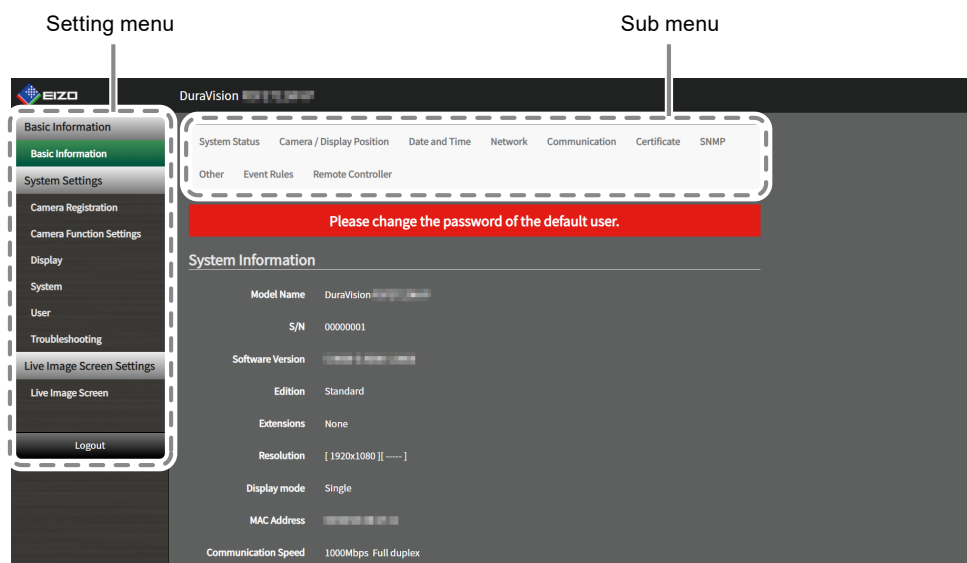

Setting menu (web console)

Note

- For the monitor console, “Return” is displayed instead of “Logout”.

Chapter 3 Live Image Screen Operations

The live image screen can be operated with a USB mouse, USB keyboard, remote control, or joystick.

- USB keyboard and remote control operations

Item	USB keyboard	Remote control
To select an item	Arrow keys	^ / v / < / >
To set a selected item	Enter key	ENTER
When deselecting a camera	Escape key	RETURN

3-1. Switch the Live Image Screen Layout

Set the number of camera images to be displayed simultaneously on the live image screen.

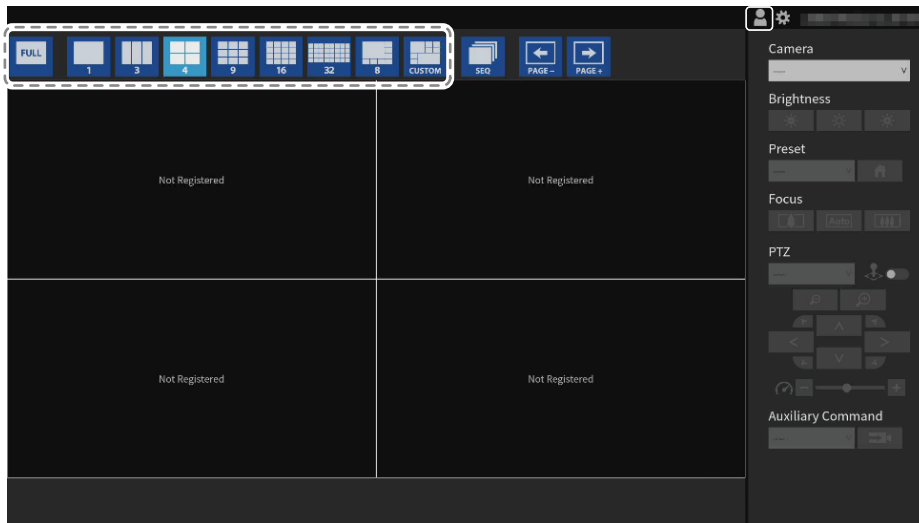

● Display in full screen

1. Click **FULL**.

The menu is hidden and the image is displayed on the entire screen. To display the menus again, double-click any place on the screen.

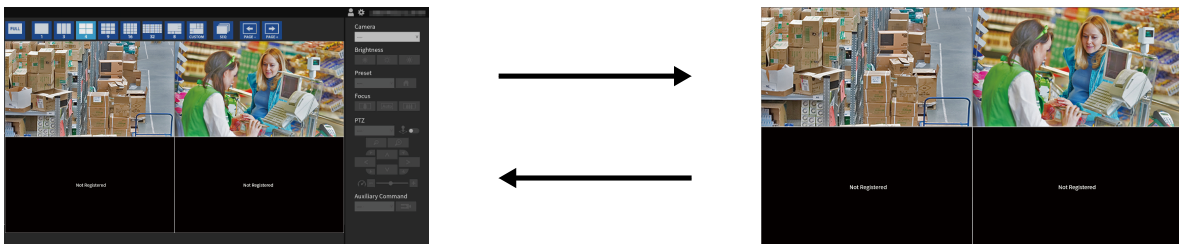

Note

- You can also use the following methods to perform this operation.
 - USB keyboard: Shortcut key (F)
 - Remote control: FULL

● Switch the screen layout

1. Click the icon for the layout you want to view.

The screen layout changes by selecting the layout icon in the display mode menu.

Note

- When using a 3 screens layout, the camera must be configured to display vertical images. For details, refer to the User's Manual of the camera.
- You can also use the following methods to perform this operation.
 - USB keyboard: Shortcut key (L)
 - Remote control: LAYOUT
- If you have an enterprise license registered, you can change the layout icon to display (refer to "6-4. Changing the Displayed Layout Icon" (page 64)).

3-2. Switch the Page Displayed on the Live Image Screen

Switch the page to display the camera image. Pages can be changed over either manually or automatically at a set interval (sequential display).

● Changing pages manually

1. Click or in the display mode menu.

Example: 4-screen layout with 16 registered cameras

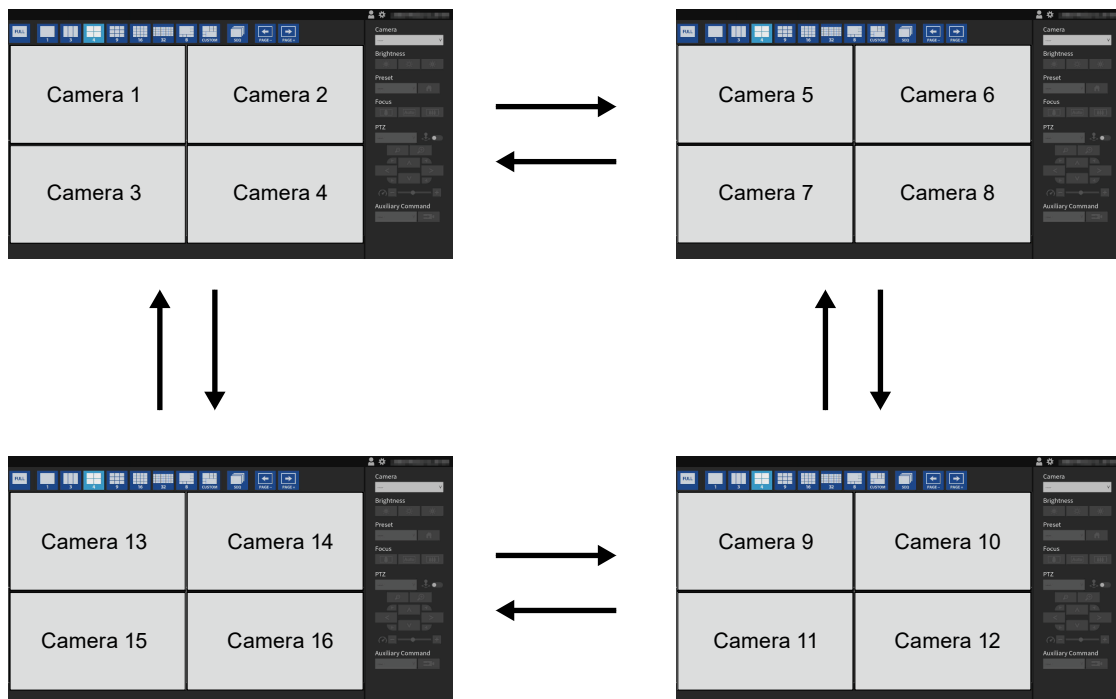

Note

- You can also use the following methods to perform this operation.
 - USB keyboard: Shortcut key (PageDown or PageUp)
 - Remote control: PAGE+ or PAGE-

● Switching pages automatically (Sequential display)

1. Click in the display mode menu.

Pages displayed on the screen are changed over automatically at a specified interval.

Note

- You can change the page switching interval on the settings screen (refer to “6-2. Setting Display Methods of Camera Video Images” (page 62)). The default setting is 10 seconds
- To stop sequence display, click  again.
- Click the camera image to stop the sequence display.
- You can also use the following methods to perform this operation.
 - USB keyboard: Shortcut key (S)
 - Remote control: SEQUENCE

3-3. Switch to Full Screen Display With 1 Screen Layout

Toggles between the current display state and full screen display with a 1 screen layout. Use a USB mouse to perform operations. It cannot be operated with a USB keyboard or remote control.

1. With the menu displayed, double-click on the camera image you want to display in full screen.

Switches to a full screen display of the 1 screen layout. Double-click the camera image to return to the original display state.

Note

- This function is disabled while in Joystick mode.

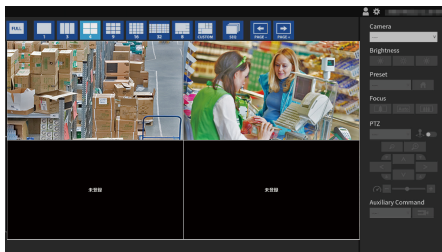

3-4. Switch camera image display positions

There are two user levels: "ADMIN" and "CAMERA CONTROL"

If the image layout is displayed in multiple screens other than one screen, camera image display positions can be switched. Use a USB mouse to perform operations. It cannot be operated with a USB keyboard or remote control.

1. Select a camera image to move using the USB mouse and drag the image and drop it on the desired camera image position.

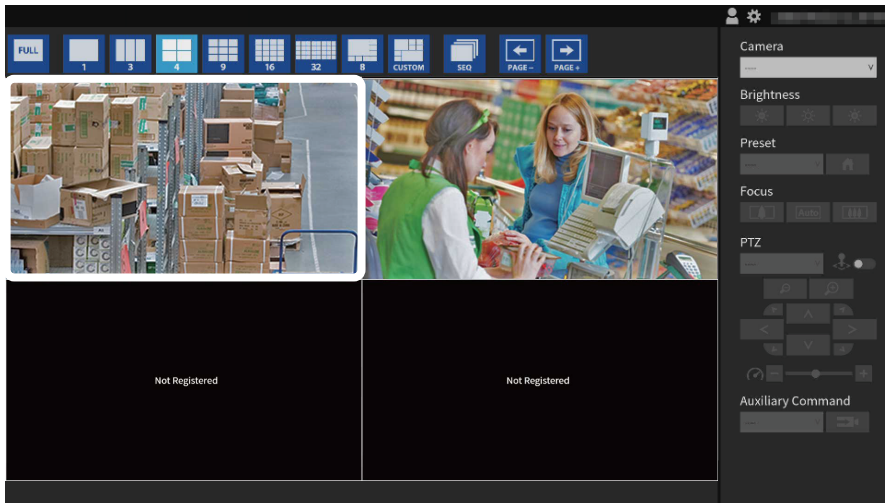

The display positions of the source and destination camera images are switched.

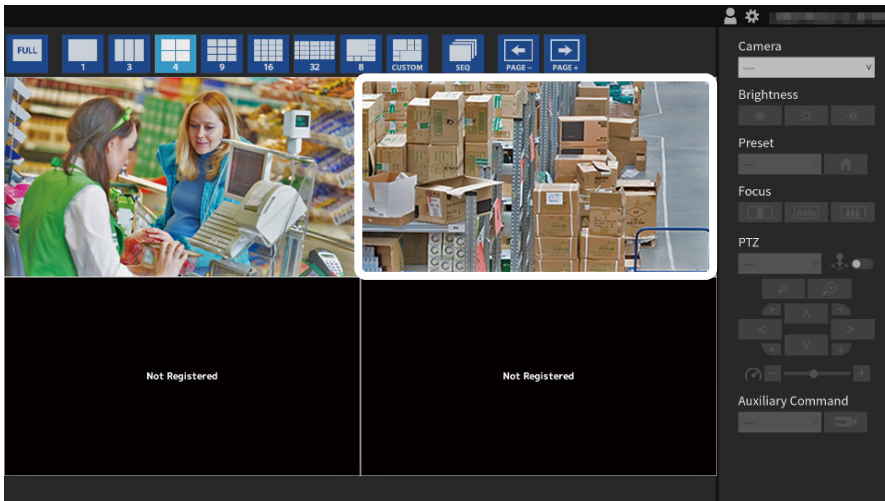

3-5. Operating Cameras

There are two user levels: "ADMIN" and "CAMERA CONTROL"

Attention

- Not all features may be available. For functions that are not available from this product or do not work as expected, please operate them on the camera side.
-

Browse

- The display position of the camera image can be changed in the settings screen (refer to "[6-1. Setting Display Positions of Camera Video Images](#)" (page 60)).
-

1. From the "Camera" list box, select the camera you wish to operate.









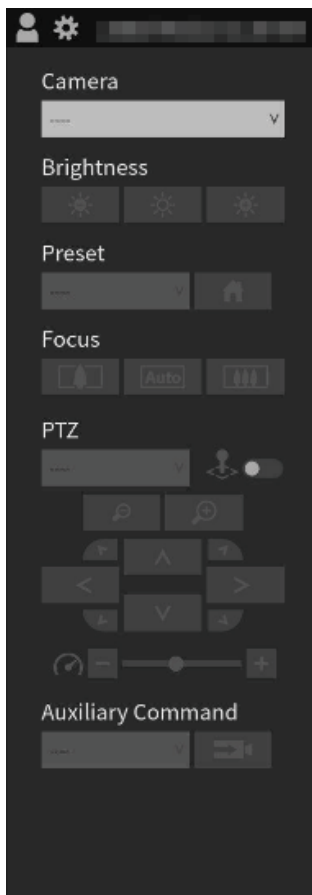



The frame of the selected camera image will be highlighted in light blue.



Note

- You can also select the camera to operate using the following methods.
 - Enter the screen number with the number keys on a USB keyboard
 - Enter the screen number with the number buttons on the remote control
 - Click the camera image with a USB mouse
-

2. Operate the functions.



Function	Description
Brightness	Adjusts the camera brightness.  : The image becomes darker.  : Returns the brightness to the default setting.* ¹  : The image becomes brighter.
Preset	Moves the camera orientation to the position registered in advance. Select  to move the camera orientation to the home position.
Focus* ⁴	Adjusts the camera focus.  : Moves the focus point closer.* ²  : Adjusts the focus point automatically.* ³  : Moves the focus point farther away.* ²
PTZ: Target selection	Selects the target for the PTZ operation.  Virtual: Performs the PTZ operation by digitally processing the camera images inside the product. Camera: Perform PTZ operations using camera functions on the camera. Note <ul style="list-style-type: none"> If you select "Virtual," PTZ operations are available regardless of the "Protocol" settings of the camera. However, the following limitations apply. <ul style="list-style-type: none"> Joystick Mode cannot be enabled. When the compression format is MJPEG, PTZ operations are not available.
PTZ: Joystick Mode	Enable when you want to continuously perform PTZ operation of a camera.  : Joystick Mode is disabled.  : Joystick Mode is enabled. Attention <ul style="list-style-type: none"> If the PTZ target is set to "Virtual," Joystick Mode cannot be enabled. Note <ul style="list-style-type: none"> You can also use the following methods to perform this operation. <ul style="list-style-type: none"> USB keyboard: Shortcut key (J) Joystick (T8311): R button
PTZ: Zoom	Adjusts the camera display magnification.  : Zooms out.  : Zooms in. Note <ul style="list-style-type: none"> You can also use the following methods to perform this operation. <ul style="list-style-type: none"> USB keyboard: Shortcut key (+ or -) Remote control: ZOOM+ or ZOOM- If Joystick Mode is enabled, you can also use the following methods to perform this operation. <ul style="list-style-type: none"> Joystick (T8311): Rotate knob USB mouse: Rotate the wheel button

Function	Description
PTZ: Position	<p>Adjusts the horizontal position (pan) and vertical position (tilt) of the camera.</p>  <p>Note</p> <ul style="list-style-type: none"> You can also use the following methods to perform this operation. <ul style="list-style-type: none"> USB keyboard, Shortcut keys (Ctrl + Up arrow key, Ctrl + Down arrow key, Ctrl + Left arrow key, or Ctrl + Right arrow key) If Joystick Mode is enabled, you can also use the following methods to perform this operation. <ul style="list-style-type: none"> Joystick (T8311): Tilt the stick USB mouse: Move the mouse while clicking the left button
PTZ: PTZ Adjust	<p>Adjusts the movement amount of the PTZ operation. The movement amount increases as the slider moves to the right.</p>  <p>Note</p> <ul style="list-style-type: none"> When using a USB keyboard, pressing the shortcut keys (Ctrl and - or Ctrl and +) adjusts the PTZ adjust.
Auxiliary Command	<p>Operates the auxiliary functions of a camera, or executes actions of registered event rules.</p> <ol style="list-style-type: none"> Select the "Auxiliary Command" list box. Select . <p>Note</p> <ul style="list-style-type: none"> The auxiliary functions of a camera can only be operated with specific devices whose protocol is set to "ONVIF" or "Panasonic/i-PRO". Event rule events can only be executed when a camera is not selected.

*1 Cannot be set for cameras in which "Protocol" or "AXIS®".

*2 If using a camera in which "Protocol" is set to "ONVIF" or "AXIS", the mode is switched to manual adjustment mode.

*3 If using a camera in which "Protocol" is set to "ONVIF" or "AXIS" the mode is switched to automatic adjustment mode.

*4 Cannot be set for cameras in which "Protocol" is set to "AXIS".

Note

- If you select a camera image in the image display area, you can perform PTZ operation using the buttons superimposed on the image.

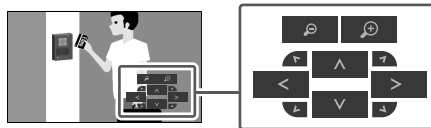

3-6. Playing Back Video Saved on a Camera's SD Card

Enterprise license

Playback extended functionality license

There are two user levels: "ADMIN" and "CAMERA CONTROL"

Video saved on a camera's SD card can be played back on the Playback screen.

Attention

- If this feature is enabled, you will see the “Playback” and “Live” tabs.
 - If the video clock is not correctly displayed, check the time zone settings of the product main unit and the network camera.
 - Playback is not supported for files recorded in MJPEG.
 - Can only be used when “Protocol” is set to “Panasonic/i-PRO” or “AXIS”.
 - The following restrictions apply when “Protocol” is set to “Panasonic/i-PRO”.
 - If the Date Filter is not enabled, up to 50 files are displayed in the “Recording Date” list starting from the oldest file.
 - One recording may be split into multiple files.
 - Only files recorded as recording stream 1 on the network camera can be played.
 - If the recording compression format is JPEG, playback will fail.
 - For multi-sensor cameras, only the channels set in the camera registration can be played.
 - The following restrictions apply when “Protocol” is set to “AXIS”.
 - If the Date Filter is not enabled, up to 50 files are displayed in the “Recording Date” list starting from the newest file.
 - Since one recording will become a single file, longer recordings will have a large file size and playback may not be possible.
 - Since one recording will become a single file, the file does not appear in the “Recording Date” list until the recording has stopped. If you set up the network camera using the following procedure, you can continue recording while splitting files at set intervals.
 1. Create a pulse in the event function “Schedule”, and set the interval to 2 minutes (when dividing the video every 2 minutes).
 2. In the event function “Rules”, set “Condition” to one created pulse event, set “Action” to “Video Recording”, set “Pre-Buffer” to “01”, set “Post-Buffer” to “01:59”, and save.
-



1. Select “Playback”.

2. From the “Camera Name” list box, select the camera.

Note

- If the “Failover” extended functionality license is valid, “Switch To Failover Cameras” is displayed. When “Switch to Failover Cameras” is enabled, the cameras that can be selected will switch to those registered for failover.
-

3. Select the video file to playback from the “Recording Date” list box.

Up to 50 files can be displayed in the “Recording Date” list box (files being recorded are not displayed). You can also select the previous file with  and select the next file with .

By using the date filter function  (filter icon), you can filter the videos displayed in the “Recording Date” list box by date.

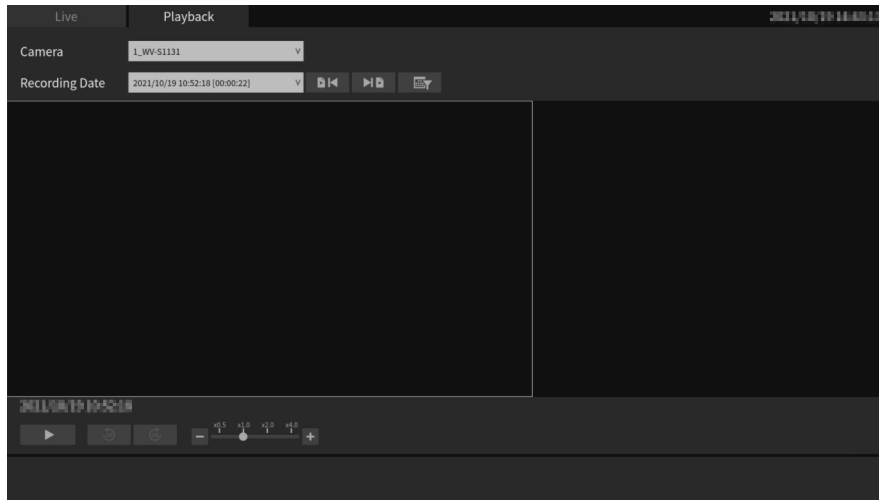

Date filter

Enable  “Date Filter”, and specify the date. Click “OK” to display up to 50 videos in the “Recording Date” list box starting from the specified date.

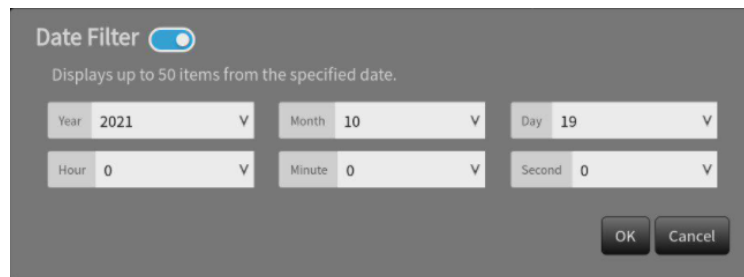







4. Press .

The video file will start downloading and the video will be played when downloading is complete.

Attention

- If the video file is a large size, the download may be interrupted and video playback may not be possible.

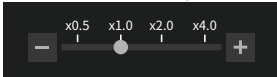
Playback Operation

Function	Description
Play / Pause	Play / Pause a video.  : Play  : Pause
10 seconds Rewind	Rewind a video by 10 seconds. 
10 seconds Fast-Forward	Fast-forward a video by 10 seconds. 
Adjust Playback Speed	Select the video playback speed from x0.5, x1.0, x2.0, and x4.0. 
Timeline	While playing a video, you can display the timeline by placing the mouse pointer in the video display area or selecting the video display area with the USB keyboard. Operate the timeline to change the playback position.  Attention <ul style="list-style-type: none"> • If you cannot get the end time of the video from the camera, the timeline cannot be displayed.

Chapter 4 System Settings

Perform settings for the date and time of the system, network settings, and maintenance.

4-1. Confirming the Basic Information

Displays the current state of each setting for this product in a list.

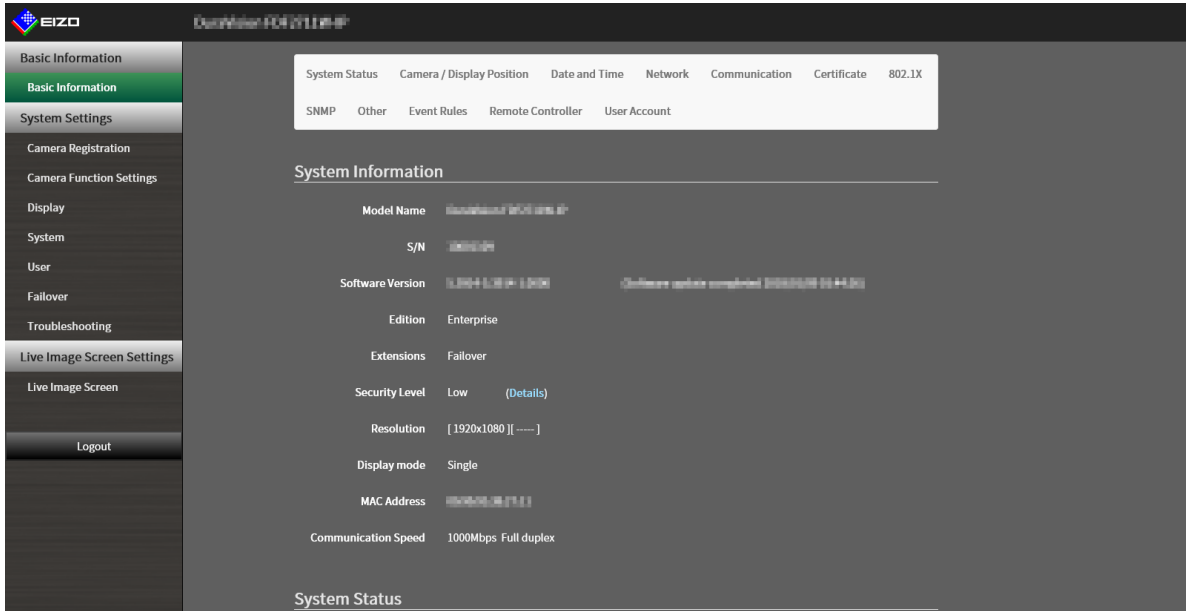

System Information

- Model Name
- S/N
- Software Version
- Edition
- Extensions
- Security Level Enterprise license
- Resolution
- Display mode
- MAC Address
- Communication Speed

Camera

Display Position

Date and Time

Network

Communication

Certificate

802.1X Enterprise license

SNMP

Other

Event Rules

Remote Controller

User Account Enterprise license

4-2. Performing Network Settings

Perform network settings such as IP address, DNS, and NTP.

1. Select “Network” of “System”.

2. Set the following items.

Network Settings

Item	Detail	Setting range
IP Setting Method	Select the IP address setting method. Note <ul style="list-style-type: none">If you have a DHCP server, select “DHCP” and the IP address will be set automatically. Since the IP address that is set cannot be checked on the web console, check it on the monitor console.	DHCP/Manual
IP Address	Set an IP address that does not overlap with another device.	0.0.0.1 to
Subnet Mask	If your network environment does not include a gateway, you do not need to set the “Gateway”. Leave either as default setting or blank. Note <ul style="list-style-type: none">The default IP address is “192.168.0.150”. When installing multiple units of this product, set unique IP addresses.	255.255.255.254
Gateway		

DNS Settings

Item	Detail	Setting range
DNS	(Only when “Manual” is selected under “IP Setting Method” of “Network Settings”)Set “DNS”.	Auto / Manual
Primary Server Address	When “Manual” is selected under “DNS”, set “Primary Server Address” and “Secondary Server Address”.	0.0.0.1 to 255.255.255.254
Secondary Server Address		

NTP Settings

Item	Detail	Setting range
NTP	Set whether to use the NTP server or not.	On / Off
Server Address	When “On” is selected, set the NTP server address.	Alphanumerics and symbols

3. Select “Apply”.

4-3. Performing Communication Settings

The communication settings are used to configure the web interface function and detection of communication errors.

1. Select “Communication” of “System”.

2. Set the following items.

Item	Detail	Setting range
Comm. Error Detection	Set the message display timing when the reception of video image data stops. <ul style="list-style-type: none">• On Within several seconds after the reception of video image data stops, an alert message is displayed in a red box on the live image screen. When communication resumes, the alert is cleared and the video image is displayed again.• Off When approx. 10 seconds have elapsed after the reception of video image data stops, a communication error message is displayed.	On / Off
Web Interface	Enables operation and setting of the product over the network from a web browser. If “Off” is selected, the settings cannot be configured from a web browser.	On / Off ^{*1}
Protocol	Select protocol for communication with the web server. ^{*2}	HTTP / HTTPS ^{*3} / HTTP and HTTPS ^{*3}
HTTP Port	Set the HTTP port of the web interface.	80, 1024 to 65535
AUTH Method	Set the authentication method for the web interface. ^{*4}	Digest authentication / BASIC authentication
HTTPS Port	Set the HTTPS port of the web interface.	443, 1024 to 65535

*1 If “USB Lock” is “On” and “Remote Controller Lock” is “On”, it cannot be set to “Off”.

*2 Depending on the protocol selected, the address may be different when accessing this product from the web browser.

“HTTP”: http://address of this product

“HTTPS”: https://address of this product

“HTTP and HTTPS”: can be accessed from either of the above

*3 Can be set when either “Self-Signed Certificate” or “CA-Signed Certificate” is selected in “Certificate”.

*4 Cannot be set when “User Account” is “LDAP”.

3. Select “Apply”.

4-4. Setting the Date and Time

Attention

- Set the correct dates. Incorrect dates may result in failure of secure communication during certificate validation. If 802.1X is in use, or if you use SSL for LDAP settings or communication with the camera, avoid having the power turned off for an extended period and make sure the correct time is set using NTP.
- If the system is not connected to the power supply for one week or longer, the date and time on the product will no longer be displayed accurately. In such a case, set the date and time again.
- If secure LDAP communication is not established, you can not login. Reset the account setting using the Reset button.

1. Select “Date and Time” of “System”.

2. Set the current date and time.

Date/Time Display Settings

Item	Detail	Setting range
Date Format	Set the date format and time format.	yyyy/mm/dd, Mmm/dd/yyyy, dd/Mmm/yyyy, mm/dd/yyyy, dd/mm/yyyy
Time Format		

Time Zone Settings

Item	Detail	Setting range
Time Zone	Set the time zone.	Region / city

Clock Settings

Item	Detail	Setting range
Procedure Only for the web console	Select the time setting procedure. When “Synchronize with PC” is selected for, the current date and time of the computer is set to this product.	Manual / Synchronize with PC
Date and Time		

3. Select “Apply”.

4-5. Configuring the Language

Sets the display language of the system.

1. Select “System” > “Other”.

2. Select a language from the “Language” list box.

3. Click “Apply”.

4-6. Initializing the System

All settings are returned to default except for system logs, operation logs, the current time, time zone settings, license activation information, and the software version.

1. Select “Maintenance” of “System”.
2. Select “Start” under “Factory Reset”.
3. Check the box if you wish to include network settings in the factory reset.

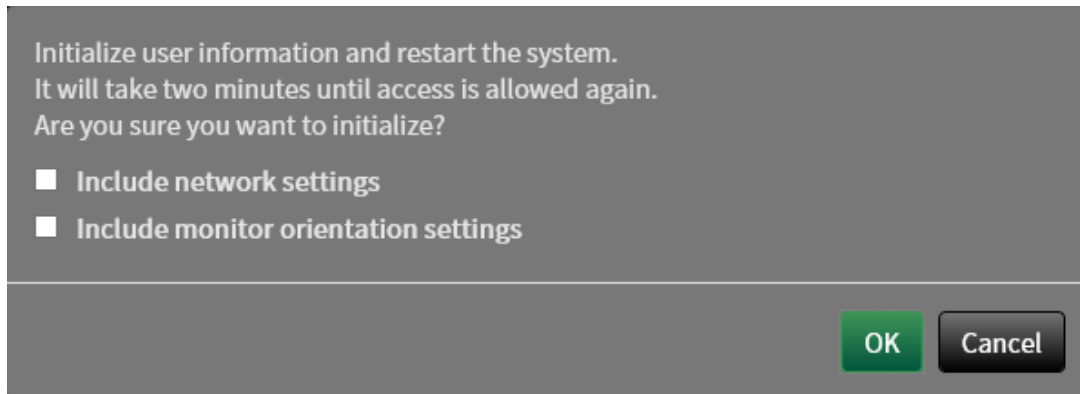

4. Select “OK”.

4-7. Restarting the System

1. Select “Maintenance” of “System”.
2. Select “Start” under “Restart”.
3. Select “OK”.

4-8. Updating Software

Only for the web console

The software version can be upgraded. Download the upgrade file from the EIZO website (www.eizoglobal.com) ahead of time. For stable operation of the system, it is recommended to use the latest software. It is not possible to revert to an older version.

1. Select “System” > “Maintenance”.

The current software version is displayed.

2. Click “Browse” under “Software Update”.

3. Select the software file (extension: duraup4).

4. Click “Start”.

5. Click “OK” in the confirmation dialog box.

The process starts.

During processing, the power indicator flashes red. Do not turn off the power. It takes approximately five minutes to update the software.

4-9. Saving Settings Data

Only for the web console

Settings data can be exported to a file. The exported file can be used to transfer settings data.

1. Select “Maintenance” of “System”.

2. Select “Save Settings Data” under “Settings Data Migration”.

3. Specify a “password” in the “Save Settings Data” dialog box.

4. Select “Execute”.

5. Specify the saving destination.

The settings data is saved.

Attention

- Some of the settings cannot be saved.
- If the password specified when saving the data is forgotten, it will no longer be possible to load the settings data.

Note

- Saved file name: (product name)_Backup(save date and time).duraconf2
-

4-10. Loading System Settings Data

Only for the web console

Load settings data from a file.

Attention

- Does not load settings that use server certificates and client certificates.
- If the environment where settings data was saved is different from the environment where settings data is loaded with respect to network settings or communication settings, you may not be able to use the web console.

1. Select “Maintenance” under “System”.

2. Select “Load Settings Data” under “Settings Data Migration”.

3. Select the settings data file and enter the password set for the file.

Attention

- Do not check “Network Settings”.
- “Camera Registration / Display” includes camera settings registered in failover.

Load Settings Data

File: No file is selected [Browse]

Password: []

Camera Registration / Display

System

- Date and Time
- Network
- Communication
- SNMP
- IP Address Filter
- Other Settings
- Event Rules
- Hotkeys
- Qognify

User

- Local User
- LDAP

Failover

Live Image Screen

[Execute] [Cancel]

4. Select “Execute”.

4-11. Registering a License

Only for the web console

The software edition can be changed. Usable functions are added when using the Enterprise edition and when extensions are enabled. For details, contact your dealer or local EIZO representative.

1. Select “Maintenance” of “System”.
2. Click “Activate” for “License Activation” and select the license file (extension: duralic).

When selecting multiple license files, click .

3. Click “Execute”.

Close the browser and wait 2 minutes before accessing again.

Note

- Select “Delete” to delete all registered licenses.
-

4-12. Setting Event Rules

Event rule is a function that executes specific actions when specific events are triggered. Allows setting actions to be executed when “Alert request received”, “Timer expired”, and “Video output status change” events occur.

Note

- A total of 16 individual Event Rules can be set.
-

1. Select “Event Rules” of “System”.
2. Select the number for registering the Event Rule.
3. Select “Setting”.

4. Set Event Rules.

Item	Detail	Setting range
Name	Enter the name of the Event Rule. To enter characters other than alphanumeric characters and symbols, use the web interface.	Any character (up to 24 characters)
Status	Select whether to enable or disable the Event Rule.	Active / Inactive
Event	Select an event to trigger an action. The items that can be set differ depending on the event.	Alert request received / Timer expired / Video output status change / Failover mode started / Auxiliary command ^{*1} / System Startup / Network Link Up / Schedule / Stream error detected
Action	Select the actions to be executed when an event occurs. The items that can be set differ depending on the action.	Notification / Start a timer / SNMP Trap / Failover Toggle / Power Management

*1 Used when live image screen auxiliary command execution is set as a trigger. Camera auxiliary commands cannot be set as triggers.

Setting Range of “Event”

Event	Conditions/Situation
Alert request received ^{*2}	Received HTTP alert command.
Timer expired	Timer set in “Action” has expired.
Video output status change	The HDMI connection status while power is on has changed.
Failover mode started	Switched to failover display.
Auxiliary command	Event executed with live screen auxiliary command.
System Startup	Main power is turned on.
Network Link Up	Network communication is enabled.
Schedule	The set day and time has arrived
Stream error detected	Data reception from the camera displayed on the live image screen has stopped for a certain period of time

*2 Sending a alert display HTTP command from external device is required. For details, contact your dealer or local EIZO representative.

Selecting “Alert request received” as an “Event”

Item	Detail	Setting range
Camera No.	Select the camera to receive the alert.	Any, from 1 to 48
Trigger Type	Select the timing of the event to occur. Select “On” when setting display alert as a trigger, and “Off” when setting hide alert as a trigger.	Any / On / Off
ID ^{*3}	Select the ID.	Any, from 1 to 16

*3 Can be set when the “Trigger Type” is “Any” or “On”.

Selecting “Timer expired” as an “Event”

Item	Detail	Setting range
Timer No.	Select the number of the timer.	1 to 8

If “Schedule” is selected for “Event”

Item	Description	Range
Execution time	Sets the time.	00:00 to 23:59
Day of Week	Selects the day of the week. Multiple selections are possible.	Mon. / Tue. / Wed. / Thu. / Fri. / Sat. / Sun.

If “Stream error detected” is selected for “Event”

Item	Description	Range
Camera No.	Select the camera to be the detection target. if a stream error occurs for a camera that is both the detection target and currently not displayed on the live image screen, it will be detected when that corresponding camera is displayed on the live image screen.	Any, 1 to 48
Detection Sensitivity	Set the time for determining a communication failure after the reception of video data has stopped. <ul style="list-style-type: none">• High If the reception of video data stops for several seconds, it determines that communication has failed.• Low If the reception of video data stops for about 10 seconds, it determines that communication has failed.	Low / High

Selecting “Notification” as an “Action”

Item	Detail	Setting range
Protocol	Select the communication protocol.	HTTP / HTTPS
URL	Enter the URL of the notification destination.	Alphanumerics and symbols (up to 32 characters)
Username	Enter the username for accessing the URL.	Alphanumerics and symbols (up to 32 characters)
Password	Enter the password for accessing the URL.	Alphanumerics and symbols (up to 32 characters)
Execute	Performs a confirmation test in order to access the specified URL.	-

Selecting “Start a timer” as an “Action”

Item	Detail	Setting range
Timer No.	Select the number of the timer.	1 to 8
Duration	Set “Minute” and “Second”.	“Minute”: 0 to 59, “Second”: 0 to 59

Selecting “SNMP Trap” as an “Action”

Item	Detail	Setting range
Trap Name	Enter the trap name.	Unicode printable characters (max. 128 characters)
Trap Message	Enter the trap message.	Unicode printable characters (max. 128 characters)
Test	Perform the SNMP trap send test.	Execute

Attention

- Set the SNMP “Trap Address” and “Trap Community” in advance.

If “Power Management” is selected for “Action”

Item	Detail	Setting range
Power Status	Select the power status.	On / Quick Shutdown

5. Select “OK”.

4-13. Registering a Server Certificate

A server certificate is used when accessing this product from a web browser via HTTPS.

Attention

- A Certificate Signing Request (CSR) cannot be created with this product.

1. Select “Certificate” of “System”.

2. Select the type from the “Type” list box.

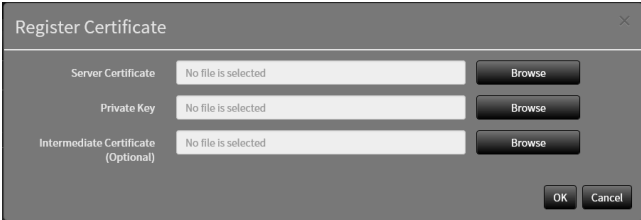
Item	Detail
Self-Signed Certificate	Click “Generate” in “Self-Signed Certificate” to generate a certificate, and then select it.
CA-Signed Certificate Only for the web console	Click “Register” in “CA-Signed Certificate” to register a certificate, and then select it. Registration of information issued from the certifying body is required for registration. 

3. Click “Apply”.

4-14. Registering a Root Certificate

Only for the web console

The root certificate is used in the following situations:

- Connecting HTTP to network cameras
- Connecting LDAPS to LDAP servers
- IEEE802.1X activation

Attention

- A Root Certificate is not pre-installed in this product.

1. Select “System” > “Certificate”.

2. Click “Register” in “Root Certificate”.

3. Click “Browse” and select the root certificate.

4. Click “OK”.

4-15. Setting the Remote Control ID

This function is for use with models equipped with a remote control.

When using multiple units of this product, the product operated by a remote control can be limited by specifying the ID shared by the product and remote control.

Note

- When the remote control ID is “0” it will operate even if the product ID and remote control ID does not match.
- The factory value of the remote control is “0”.

● Setting the product ID

1. Select “Remote Controller” of “System”.

2. Set the following items.

Item	Detail	Setting range
ID	Select the number that will be the ID.	0 to 99
Display ID	When set to “On”, the ID is displayed in the upper right of the Live Image Screen when the ID button of the remote control is pushed.	On / Off

3. Select “Apply”.

● Setting the remote control ID

1. Press and hold **ID** for more than 3 seconds.

2. With **ID** pressed, enter the ID (0 to 99) you want to set with the number buttons.

Note

- If the ID you want to set is a single digit number, enter 0 before it.
(Ex: To set “3”, enter “03”.)

3. Release **ID**.

Note

- When confirming the ID of the remote control, set “Display ID” to “On”, and press **ID**.
The current ID is displayed in the upper right of the Live Image Screen.

4-16. Configuring USB Device Hotkeys

It is possible to operate the live image screen using the buttons on a USB device (excluding USB mouse, USB keyboard).

Note

- Supported USB devices are shown below.
 - AXIS T8311 (Joystick)

1. In “System”, select “Hotkeys”.
2. Select a USB device to be set from “Devices”.
3. Set the function of each button.

List of Functions

Item	Description
Vollbild	Displays/hides the live image screen menus.
1 Screen Layout	Changes the layout of the live image screen to 1 screen.
3 Screens Layout ^{*1}	Changes the layout of the live image screen to 3 screen.
4 Screens Layout ^{*1}	Changes the layout of the live image screen to 4 screen.
9 Screens Layout ^{*1}	Changes the layout of the live image screen to 9 screen.
16 Screens Layout ^{*1}	Changes the layout of the live image screen to 16 screen.
32 Screens Layout ^{*1}	Changes the layout of the live image screen to 32 screen.
8 Screens Layout ^{*1}	Changes the layout of the live image screen to 8 screen.
Custom Screen Layout ^{*1}	Changes the layout of the live image screen to Custom.
Sequence Mode	Turns the sequence display (mode that switches the pages to be displayed at regular intervals) of camera images on or off.
Page Up	Switches the camera images to be displayed on the live image screen to the next page.
Page Down	Switches the camera images to be displayed on the live image screen to the previous page.
Preset 1 ^{*1}	Changes the layout of the live image screen to preset 1.
Preset 2 ^{*1}	Changes the layout of the live image screen to preset 2.
Preset 3 ^{*1}	Changes the layout of the live image screen to preset 3.
Preset 4 ^{*1}	Changes the layout of the live image screen to preset 4.
Preset 5 ^{*1}	Changes the layout of the live image screen to preset 5.
Preset 6 ^{*1}	Changes the layout of the live image screen to preset 6.
Preset 7 ^{*1}	Changes the layout of the live image screen to preset 7.
Layout Change	Switches the layout of the live image screen each time the button is pressed.
JoyStick Mode ^{*2}	Switches Joystick Mode on or off.
Mouse Left ^{*2}	Mouse Left Click.

*1 Can be set only when set to be displayed on the live image screen.

*2 Is set as default on specific USB devices. Can be set only to buttons where it is the default setting.

AXIS T8311 Default Setting

Item	Description
J1	Full Screen
J2	Layout Change
J3	Page Up
J4	Page Down
L ^{*3}	Mouse Left
R ^{*3}	JoyStick Mode

*3 Cannot be changed.

4. Select “Apply”.

4-17. Setting IEEE 802.1X Authentication

Enterprise license

Note

- This product operates using EAPOL version 2 (IEEE 802.1X-2004).

1. Select “802.1X” under System.

2. Set the following items.

Item	Description	Range
Authentication	Select the authentication method.	Off / EAP-TLS / EAP-PEAP
Certificate Validation	Select server certificate validation. Attention <ul style="list-style-type: none">• When performing certificate validation, it is necessary for the root certificate of the authentication server to be registered in “Root Certificate” of “Certificate” of this product.	Off / On
Identity	Enter a username.	Alphanumerics and symbols (Up to 32 characters)

Selecting “EAP- TLS” in Authentication

Select “Register” in “Client Certificate” and set the following items.

Item	Description	Range
Client Certificate Only for the web console	Sets the client certificate.	-
Private Key	Sets the private key.	-

Selecting “EAP- PEAP” in Authentication

Select “Register” in “Client Certificate” and set the following items.

Item	Description	Range
Password	Enter a password.	Alphanumerics and symbols (Up to 32 characters)

3. Click “Apply”.

4-18. Setting the product SNMP

You can set SNMP information acquisition or SNMP trap as an event rule action.

1. Select “SNMP” under System.

2. Select “Version”.

3. If “Version” is “v1 & v2c”, set each item.

Item	Description	Range
Read Community	Enter the read community.	Alphanumerics and symbols (Up to 32 characters)
Trap Address	Enter the SNMP trap notification address of the Event Rule.	0.0.0.1 to 255.255.255.254
Trap Community	Enter the trap community.	Alphanumerics and symbols (Up to 32 characters)

4. Click “Apply”.

Attention

- If the “Read Community” row is empty SNMP information acquisition cannot be performed.
 - If the “Trap Address” and “Trap Community” rows are empty the event rule SNMP trap will not operate.
-

EIZO MIB structure

When using SNMP with this product, it is necessary to import the following modules into the SNMP manager. Download the MIB file from the EIZO website (www.eizoglobal.com) ahead of time.

- EIZO-ROOT-MIB
- EIZO-SECURITY-MIB
- EIZO-DECODER-MIB

MIB Tree

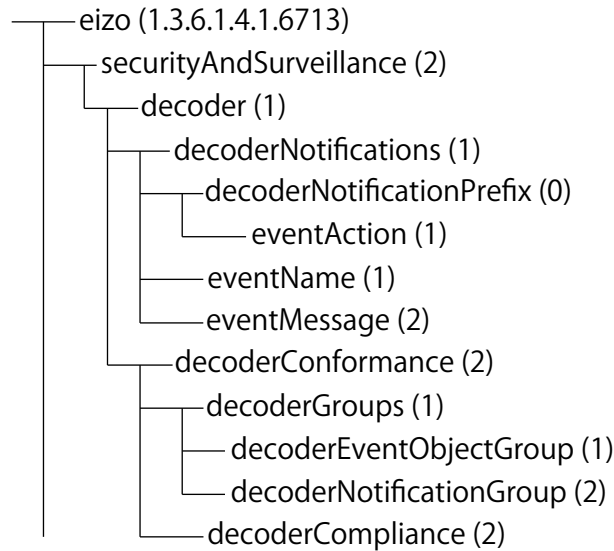

Name	OID	TYPE	SYNTAX	MAX-ACCESS	Description
eventAction	.6713.2.1.1.0.1	NOTIFICATION-TYPE	-	-	Trap when executing actions
eventName	.6713.2.1.1.1	OBJECT-TYPE	SnmpAdminString	accessiblefor-notify	Event name defined in the event rules
eventMessage	.6713.2.1.1.2	OBJECT-TYPE	SnmpAdminString	accessiblefor-notify	Event message defined in the event rules

4-19. Setting an IP Address Filter

Limit the IP address of computers that can access the system.

Attention

- If the IP address filter is not set up correctly, it will not be possible to access this product.
 - If “IP Address Filter” is set to “On” the camera will not be found when performing camera search.
 - If “IP Address Filter” is set to “On” the communication for receiving camera images is not limited.
-

1. Select “IP Address Filter” under System.

2. Set the following items.

Item	Description	Range
IP Address Filter	Select whether to enable or disable the function.	Off / On
Permitted IP Address Settings	Enter the IP addresses of the computers permitted access. Enter using CIDR notation if setting an IP address range.	0.0.0.1 to 255.255.255.254

3. Click “Apply”.

4-20. Setting Failover

Enterprise license

Failover extended functionality license

When failover is enabled, alive monitoring is performed for the displayed network camera. If an error occurs or data reception from a camera stops for a certain period of time, the system determines that a failure has occurred and switches the display to the registered failover camera set. When switching to failover the camera image border displays in yellow.

Note

- Perform any of the following operations to switch the display from failover to the regular camera set.
 - Go to the main unit settings screen then return to the camera display screen.
 - Register “Failover” in the event rules and use an auxiliary command.
 - From the Web browser, go to “System Status Settings” under “Live Image Screen”, then set “Camera Mode” to “Standard”.

● Failover Settings

1. Select “Failover Settings” under Failover.

2. Set the following items.

Item	Description	Range
Failover	Select whether to enable or disable the function.	Off / On
Detection Method	Select the detection method. Note <ul style="list-style-type: none">• Failure detection is performed only for the camera currently displayed. Cameras that are not displayed are not applicable.	Failure with all cameras / Failure with any camera
Detection Sensitivity	Sets the time required to pass after video data reception has stopped for a communication failure to be detected. <ul style="list-style-type: none">• High If video data reception stops for several seconds, a communication failure is detected.• Low If video data reception stops for about 10 seconds, a communication failure is detected.	Low / High

3. Click “Apply”.

● Camera Registration

Register the failover network cameras.

1. Select “Camera Registration” under Failover.

2. Register the camera while browsing the following items.

[“5-1. Registering a Camera Using Auto Discovery” \(page 50\)](#)

[“5-2. Registering a Camera Manually” \(page 51\)](#)

[“5-3. Changing Network Camera Information” \(page 55\)](#)

[“5-4. Deleting Network Cameras” \(page 55\)](#)

[“5-5. Importing Network Camera Information” \(page 56\)](#)

● Camera Function Settings

Set the failover network camera time, transmission image quality, and preset position.

1. Select “Camera Function Settings” under Failover.

2. Configure the camera by referring to the following.

[“5-6. Setting Network Camera Time” \(page 56\)](#)

[“5-7. Setting Quality of Transmission Video Images” \(page 57\)](#)

[“5-8. Registering the Network Camera Preset Position” \(page 59\)](#)

● Display Position Settings

Set the failover network camera image display position.

1. Select “Display Position Settings” under Failover.

Note

- Check the “Show Standard Cameras” to activate the display of the name of the network cameras usually used.
-

2. Configure the camera by referring to the following.

[“6-1. Setting Display Positions of Camera Video Images” \(page 60\)](#)

● Overlay Settings

It is possible to display privacy masks or virtual lines on camera images of the failover network camera.

1. Select “Overlay Settings” under Failover.

Note

- After selecting “Camera Name” you can load settings of the network cameras that are usually used by clicking “Load Settings”.
-

2. Set the overlay items while browsing the following items.

[“6-6. Setting the Overlay” \(page 67\)](#)

● Preset Settings

Register the preset position of the failover network cameras.

1. Select “Preset Settings” under Failover.

Note

- Check the “Show Standard Cameras” to activate the display of the name of the network cameras usually used.
-

2. Configure the camera by referring to the following.

[“5-8. Registering the Network Camera Preset Position” \(page 59\)](#)

4-21. Checking Logs

This system records operation logs and system logs. They can be used to check the current or past conditions of the system or to find out the cause when a problem occurs.

1. Select “Log Display” of “Troubleshooting”.
2. Select “Operation Log Display” or “System Log Display”.

The log is displayed in the lower area.

4-22. Saving Logs

Only for the web console

Save operation logs and system logs.

Use these logs to check the current or past conditions of the system or to find out the cause when a problem occurs.

1. Select “Log Display” of “Troubleshooting”.
2. Select “Operation Log Display” or “System Log Display”.
3. Select “Save”.

4-23. Check basic Information

Displays the basic Information of the product. You can use this to check the current settings of the system and find the cause of a problem when it occurs.

1. Select “Troubleshooting” > “Log Display”.
2. Click “Basic Information Display”.

Basic information is displayed in the area below.

4-24. Save basic Information

Only for the web console

Saves the basic Information of the product. You can use this to check the current settings of the system and find the cause of a problem when it occurs.

1. Select “Troubleshooting” > “Log Display”.
2. Click “Basic Information Display”.
3. Select “Save”.

4-25. Performing Camera Connection Confirmation

Only for the web console

The connection status of the network cameras can be confirmed.

1. Select “Connection Confirmation” of “Troubleshooting”.
2. Select “Camera Name”.
3. Select “Run” for “ping” or “traceroute”.

The connection status is displayed in the lower area.

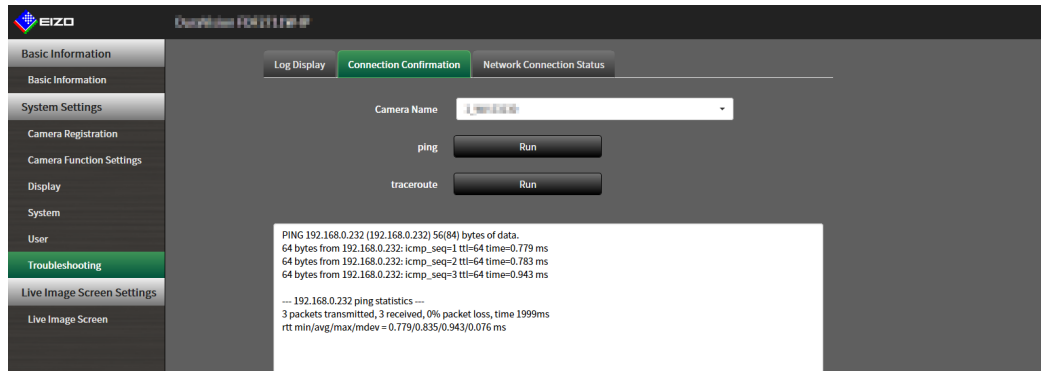

4-26. Confirming Network Connection Status

1. Select “Network Connection Status” of “Troubleshooting”.

Displays the current communication bandwidth (sending, receiving).

2. Select “Current Status”.

The connection status is displayed in the lower area.

Note

- Select “Reconnect” to reset the network status. The connection status is not displayed.
-

4-27. Configuring Monitor Display Settings

Configure the settings related to the display of the monitor.

1. Select “Other” under “System”.

2. Set the following items.

Item	Description	Range
Resolution ^{*1}	Select an output resolution to the monitor.	1920x1080 / 2560x1440 / 3840x2160
Multi-Monitor	Select the method for outputting the signal from the HDMI connector on the back.	Single / Extended / Duplicate
Orientation Enterprise license	Switch the direction of the video output from the product.	Landscape / Portrait
Rotate Enterprise license	Set the rotation direction for the system output video when “Orientation” is “Portrait”. Note • For FDF2712W-IP / FDF2312W-IP, “Primary” cannot be set.	Left / Right

*1 This setting applies only for DX0212-IP.

3. Click “Apply”.

4-28. Performing Other Settings

1. Select “Other” under “System”.

2. Set the following items.

Item	Description	Range
Key Lock	Locks operations by buttons on the front of the product.	On / Off
USB Lock Only for the web console	Locks operations of the USB device. Attention • When the setting is changed, the product needs to be restarted.	On / Off
Remote Controller Lock Only for the web console	Lock the operation of the remote control. (A function for use with models equipped with a remote control)	On / Off
Logo ^{*1}	Set whether or not to display the logo at startup.	On / Off
Power Indicator	Sets whether to turn the power indicator (blue) on or off under normal operation.	On / Off
Keyboard Layout	Select the keyboard arrangement.	Japanese / English(US) / English(UK) / German

*1 This setting applies only to FDF2712W-IP / FDF2312W-IP.

3. Click “Apply”.

4-29. Linking with a Qognify VMS

Enterprise license

Qognify extended functionality license

You can control this product directly from a Qognify VMS (Video Management Software).

For details, refer to “User’s Manual” for Video Wall Integration for Qognify”. “User’s Manual” for Video Wall Integration for Qognify” can be downloaded from the EIZO website (www.eizoglobal.com).

4-30. Streaming Gateway Function Settings (DX0212-IP)

Enterprise license

Only for the web console

The streaming gateway function converts video from the camera to the RTSP protocol or the secure and reliable SRT protocol, allowing it to be streamed to another system. There are two modes: “Merge mode”, which streams the video from the live image screen, and “Relay mode”, which streams individual camera images.

Streams sent through the streaming gateway function can be received on other EIZO IP decoders (by setting “Protocol” to “EIZO Streaming Gateway”).

- Merge mode

This mode converts the display of the live image screen into the RTSP or SRT protocol for streaming. By streaming multiple camera images freely laid out on the screen (live image screen) as a single stream, it reduces the network load.

- Relay mode

In this mode, images received directly from each camera are streamed again without any processing using the RTSP or SRT protocol. It allows increasing the number of streams without putting additional streaming load on the cameras.

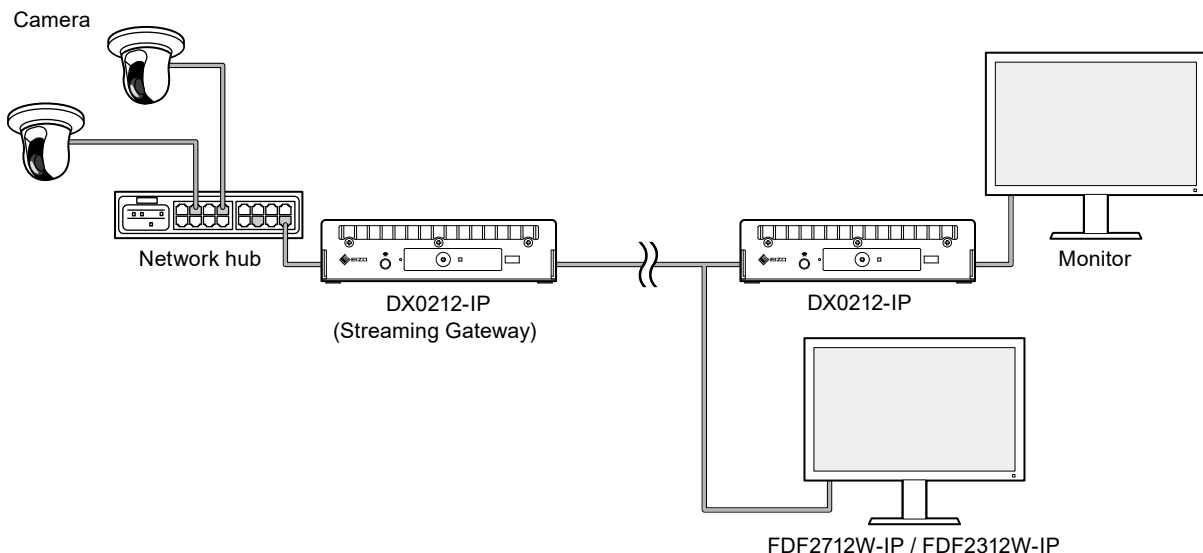

● Streaming Gateway Settings

1. Select “Streaming Gateway” > “Streaming Gateway Settings”.

2. Set the following items.

Streaming gateway settings

Item	Description	Range
Streaming mode	Selects the streaming mode. If "Off" is selected, the streaming gateway function will be disabled.	Merge mode / Relay mode / Off

Protocol Settings

Item	Description	Range
RTSP - Username	Enter the RTSP username.* ¹	Alphanumeric characters and symbols (up to 32 characters) excluding ‘ “ ? / \ { } ~ % : ` ,`
RTSP - Password	Enter the password of the RTSP.* ¹	Alphanumeric characters and symbols (up to 32 characters) excluding ‘ “ ? / \ { } ~ % : ` ,`
RTSP - Port	Enter the port number of the RTSP.	554 / 1024 to 65535
RTSP - RTP Packets Size	Sets the size of RTP packets to be sent (unit: bytes).	400 to 1400
SRT - Encryption	Select the encryption method.	AES-128 / AES-192 / AES-256 / None
SRT - Passphrase	Sets the passphrase.* ²	Alphanumeric characters and symbols (10 to 79 characters)
SRT - TS Packets Count	Sets the number of TS packets to insert in the SRT packet to be sent.	1 to 7

*1 Set according to your environment. You can set both the username and password as blank (if only one of them is blank, it cannot be set). When both are left blank, streaming will be sent without authentication.

*2 Set according to your environment. It can be set even if it is blank. When both are left blank, streaming will be sent without authentication.

3. Click “Apply”.

Attention

- If you enable the streaming gateway function, the display on the monitor connected to the HDMI 1 connector will switch to a blue screen, and operations from the monitor console will be disabled.
- If "Streaming mode" is set to "Merge mode", check the following points.
 - The screen will forcibly transition to the live image screen.
 - "Full Screen Display" in "Live Image Screen" > "Live Image Screen Settings" will automatically change to "On".
 - "Multi-Monitor" in "System" > "Other" will automatically change to "Single Screen". Streaming in "Extended" display is not possible (for the "Orientation" you can stream in both "Landscape" and "Portrait").
- If "Streaming mode" is set to "Relay mode", check the following points.
 - Outputs the received video data from the camera as is without any processing. The resolution or frame rate cannot be changed.
 - MJPEG streams cannot be streamed.
 - Before setting Relay mode, ensure that the camera image is correctly displayed on the live image screen of the main unit.

● Streaming Settings

1. Select “Streaming Gateway” > “Streaming settings”.

2. Set the following items.

Item	Description	Range
Camera Name ^{*1}	If "Streaming mode" is "Merge mode", it will display "Live_View". If "Streaming mode" is set to "Relay mode", it will display the same camera name used on the "Camera Registration" screen.	-
Encode ^{*2}	Select the encoding settings. Set each of the encoding settings in “Encoding Settings” (page 48).	Encoding Setting 1 / Encoding Setting 2
Protocol	Select the protocol.	RTSP / SRT / RTP
IP Address ^{*3}	Enter the IP address.	0.0.0.1 to 255.255.255.254 (excluding multicast range (224.0.0.0 to 239.255.255.255))
Port ^{*4}	Enter the port number.	1024 to 65535
MPEG2-TS ^{*5}	Select to enable/disable the function. If "Enabled" is selected, MPEG2-TS over RTP will be used for streaming.	On / Off
Status ^{*1}	Displays the current status.	-

*1 Read-only.

*2 Can be set if "Streaming mode" is "Merge mode".

*3 This can be set when “Protocol” is “RTP”.

*4 Can be set if "Protocol" is set to "SRT". Set a port number that does not overlap with another camera.

*5 Can be set if "Protocol" is set to "RTSP".

3. Click “Apply”.

● Encoding Settings

1. Select “Streaming Gateway” > “Encoding Settings”.

2. Set the following items.

Item	Description	Range
Compression Format	Select the compression format.	H.264 / H.265
Resolution	Select the resolution.	1920x1080 / 1280x720 / 640x360
Video Quality	Set the video quality.	10 to 100 (in 10 units)
Frame Rate	Set the frame rate (video update interval).	1 to 30
Bit rate	Set the bitrate.	512 to 8192
GOV Length	Set the I-frame interval.	1 to 60
Profile	Select the profile. If "Compression Format" is "H.265", it will be set to "Main".	Baseline / Main / High

3. Click “Apply”.

Streaming capabilities of the streaming gateway function

The Streaming capabilities of the streaming gateway function are as follows.

Communication bandwidth

- Receiving bandwidth: 100 Mbps
- Sending bandwidth: 300 Mbps

Relay mode

Video input from camera		Streaming gateway streaming
Comm. Method	Maximum number of connections	Maximum number of connections (RTSP protocol)
RTP over RTSP	48	96

* Streaming via the SRT protocol supports one output stream for each input stream.

Merge mode

Video input from camera		Streaming gateway streaming
Comm. Method	Maximum number of connections	Maximum number of connections (RTSP protocol)
RTP over RTSP	32	32

* Streaming via the SRT protocol supports one output stream for each encoding setting.

Attention

- The values are provided for reference.
 - If the streaming image is distorted, check the following points.
 - Reduce the number of streams from the camera for video input. For Merge mode, by setting the "Suspend while in Background" function in "Advanced Settings" to "On", you can stop communication for cameras on pages that are not displayed to reduce the number of streams.
 - Reduce the bit rate.
-

Chapter 5 Management of Network Cameras

This section describes the procedure for network camera registration and function settings, and to reflect them on the system.

5-1. Registering a Camera Using Auto Discovery

Cameras connected to the network can be automatically detected and registered.

Attention

The following cameras and video encoders must be registered manually (refer to “5-2. Registering a Camera Manually” (page 51)).

- Cameras that cannot be discovered automatically
 - Cameras on different subnets cannot be discovered automatically.
 - Some cameras can be set to deny auto discovery or allow auto discovery only for a certain period of time after the camera is turned on.
- Fisheye/panoramic cameras with multiple video streams
- Video encoder with multiple cameras connected

1. Select “Camera Registration”.

2. Click “Auto Discovery”.

3. Set the following items.

Item	Description
Protocol	Select the protocol for controlling the camera. “Panasonic/i-PRO”: Panasonic/i-PRO camera “AXIS”: Axis camera (VAPIX®) “ONVIF ^{*1} ”: ONVIF Profile S compatible camera
Username	Enter the username of the camera. A user with administrator privileges is required.
Password	Enter the password of the camera.

*1 If “Protocol” is set to “ONVIF”, “Media Type” will be “Media1”.

4. Click “OK”.

A list of discovered cameras is displayed.

Auto discovery of cameras depends on the camera and network. Cameras that do not appear in the list must be registered manually.

5. Check the camera to register, and select “Add”.

6. Click “Apply”.

The camera image is displayed on the live screen.

5-2. Registering a Camera Manually

The following cameras and video encoders must be registered manually.

- Cameras that cannot be discovered automatically
- Fisheye/panoramic cameras multiple streams of different images
 - Register multiple fisheye/panoramic cameras with the same IP address and specify which stream to display.
- Video encoder with multiple cameras connected
 - Register multiple video encoders with the same IP address and specify the streams to be displayed. For Panasonic/i-PRO video encoders that support multiple channels, specify the camera to be displayed in "Channel".

1. Select "Camera Registration".

2. Check the position number to register, and click "Manual Registration".

3. Set each item in the manual registration dialog box.

The displayed items vary depending on the protocol. First select "Protocol".

Item	Detail	Setting range
Camera Name	Enter the camera name. To enter characters other than alphanumeric characters and symbols, use the web console. Enter "IP Address", "Port", "Username", "Password" and click "Obtain Camera Name" to get the camera name from the camera.	Any character (up to 100 characters)
IP Address	Enter the IP address of the camera.	0.0.0.1 to 255.255.255.254
"Ping" button	Executes a connection test with the camera.	-
Port	Enter the port number of the camera. Note <ul style="list-style-type: none"> • Typical port numbers are "80" ("443" if SSL is enabled) when "Protocol" is "Panasonic/i-PRO", "AXIS", "ONVIF", and "554" when "Protocol" is "DirectUri" and "URI" is an RTSP stream URI. • If "Protocol" is set to "EIZO Streaming Gateway," enter the access port of the Streaming Gateway web server (default: 80). • If "Protocol" is set to "Qognify", enter the server access port of the Qognify VMS (default: 62000). 	1 to 65535
SSL	Provides secure communication. Attention <ul style="list-style-type: none"> • The camera must be set with a server certificate. • The video is not encrypted. Video is encrypted when "Protocol" is "SRT" or when "Protocol" is "AXIS" and "Transmission Mode" is "SRTP over UDP" 	-
Certificate Validation	Select certificate validation during SSL communication. Attention <ul style="list-style-type: none"> • If "Certificate Validation" is "On", the, it is necessary for the root certificate of the camera to be registered in "Root Certificate" under "Certificate". 	On / Off

Item	Detail	Setting range
Protocol	Select the protocol for controlling the camera. <ul style="list-style-type: none"> • Panasonic/i-PRO Panasonic/i-PRO camera • AXIS Axis camera (VAPIX) • ONVIF ONVIF Profile S compatible camera • DirectUri Select to connect to a RTSP stream URI (URI starting with rtsp://) or a RTP stream URI (URI starting with rtp://). • SRT Select to connect to an SRT stream URI. • EIZO Streaming Gateway Select this when connecting to DX0212-IP*³ with the streaming gateway function enabled. • Qognify Select this when linking with a Qognify VMS. 	Panasonic/i-PRO / AXIS / ONVIF / DirectUri / SRT* ¹ / EIZO Streaming Gateway / Qognify* ²
Username	Enter the username of the camera. A user with administrator privileges is required.	Alphanumeric characters and symbols (up to 32 characters)
Password	Enter the password of the camera.	Alphanumeric characters and symbols (up to 32 characters)

*1 This can be selected when an enterprise license and an “SRT” extended functionality license are registered for this product.

*2 This can be selected when an enterprise license and a “Qognify” extended functionality license are registered for this product.

*3 The streaming gateway function settings must be completed in advance.

When “Panasonic/i-PRO” is selected

Unicast/Multicast cannot be set from this product. Change the transmission mode on the camera side.

Item	Detail	Setting range
Comm. Method	Select the communication method for camera video images.	RTP over UDP
Stream	Select the stream to connect to.	1 / 2 / 3 / 4
Channel	Select a stream channel.	1 / 2 / 3 / 4
RS485PTZ Control	Set whether to operate the RS485 pan tilt platform from a camera that supports RS485 communication.	On / Off

When “AXIS” is selected

Item	Detail	Range
Video Stream	Select the view area for the stream. Click “Obtain Stream” to get a list of view areas from the camera. Note • The view area is used to stream a portion of the entire image. For details, refer to the User’s Manual of the camera.	Depends on the camera
Stream Profile	Specify the stream to connect to by selecting a stream profile. Click “Obtain Profile” to get a list of profiles from the camera. Note • If no profile is registered on the camera, this product will automatically register the “EIZO_Profile” profile to the camera.	Depends on the camera
Transmission Mode	Select the transmission mode.	Unicast / Multicast
Comm. Method	Select the communication method for camera video images.	RTP over UDP / RTP over RTSP / SRTP over UDP*1

*1 This can be selected when an enterprise license is registered for this product. If you select “SRTP over UDP”, check “SSL”. In addition, enable the SRTP setting on the camera.

When “ONVIF” is selected

Item	Detail	Range
Media Type	Select the media type. • Media1 (default setting) Select when connecting to H.264 or MJPEG streams. • Media2 Select to connect to H.265 and H.264 streams.	Media1 / Media2
Media Profile	Specify the stream to connect to by selecting a media profile. Click “Obtain Profile” to get a list of profiles from the camera.	Depends on the camera
Transmission Mode	Select the transmission mode.	Unicast / Multicast
Comm. Method	Select the communication method for camera video images.	RTP over UDP / RTP over RTSP

When “DirectUri” is selected

Item	Detail	Range
URI	Enter the RTSP stream URI (URI starting with rtsp://, http://, or https://) or RTP stream URI (URI starting with rtp://).	Alphanumeric characters (up to 1023 characters)
Transmission Mode	Select the transmission mode.	Unicast / Multicast / Source-Specific Multicast
Comm. Method	Select the communication method for camera video images	RTP over UDP / RTP over RTSP / MPEG2-TS over UDP / RTSP over HTTP / RTSP over HTTPS

Note

- To receive an MPEG2-TS stream with RTP, select “RTP over UDP” or “RTP over RTSP” in “Comm. Method”.
- To receive an MPEG2-TS stream over UDP, check the following points.
 - Specify the port number (1024 to 65535) that receives the stream in “Port” and select “MPEG2-TS over UDP” in “Comm. Method”.
 - You should make stream transmission settings for this product from the transmitter in advance.
 - For non-multicast communication, leave the IP address blank.

When “SRT” is selected

This product operates in Caller mode. Set the camera to Listener mode.

Item	Detail	Range
Latency	Set the latency	20 ms to 8000 ms
URI	Enter the SRT stream URI (URI starting with rtp://).	Alphanumeric characters (up to 1023 characters)
Passphrase	Sets the passphrase.	Alphanumeric characters and symbols (up to 79 characters)

When “EIZO Streaming Gateway” is selected

Item	Description	Range
Stream List	Specify the stream to connect to. Click the "Obtain Stream List" button to get a list of streams from the transmitter. Attention <ul style="list-style-type: none">If “Streaming Gateway” > “Streaming settings” > “Protocol” of the source is set to “RTP”, you cannot select that stream.	-
RTSP - Username	The RTSP username is automatically set. It can also be changed.	Alphanumeric characters and symbols (up to 79 characters)
RTSP - Password	The RTSP password is automatically set. It can also be changed.	Alphanumeric characters and symbols (up to 79 characters)
RTSP - Connection method	Select the communication method for camera video images.	RTP over RTSP
SRT - Latency ^{*1}	Set the latency.	20 ms to 8000 ms
SRT - Passphrase ^{*1}	The passphrase is automatically set. It can also be changed.	Alphanumeric characters and symbols (up to 79 characters)

*1 This can be selected when an enterprise license and an "SRT" extended functionality license are registered for this product.

When “Qognify” is selected

Item	Description	Range
Camera List	Click the "Obtain Camera List" button to display the acquired information.	-
Comm. Method	Select the communication method for camera video images.	RTP over RTSP

4. Click “OK”.

5. Click “Apply”.

The camera image is displayed on the live screen image.

5-3. Changing Network Camera Information

1. Select “Camera Registration”.
2. Check the camera position number to change, and click “Manual Registration”.
3. Set each item and select “OK”.

Note

- For details, refer to step 3 under [“5-2. Registering a Camera Manually” \(page 51\)](#).
-

4. Click “OK”.
5. Click “Apply”.

5-4. Deleting Network Cameras

1. Select “Camera Registration”.
2. Check the position number of the camera to be deleted and click “Delete”.
3. Select “OK”.
4. Select “Apply”.

5-5. Importing Network Camera Information

Only for the web console

A CSV file that contains additional camera candidates can be imported and used for registration.

Note

- Up to 255 candidate cameras can be read.
 - The CSV files that can be read are as follows.
 - CSV file saved with the “Save Camera Information” function (“Save Camera Information” is a function available in version 6.0 or earlier.)
 - CSV files created by the user
 - For details on readable CSV file formats, refer to “8-6. CSV File Format for Camera Registration” (page 87).
 - If “CameraName” appears garbled, the character code may be other than Unicode UTF-8. In such a case, change it to Unicode UTF-8.
-

1. Select “Camera Registration”.

2. Select “Load Camera Information”.

3. Select the CSV file that contains the network camera information and select “Open”.

4. Select a camera to be added from the list of candidates and select “Add”.

5. Select “Apply”.

5-6. Setting Network Camera Time

Adjust the time of the network camera to the time of this product.

Attention

- Cannot be set if the camera does not support this function.
 - Can only be set when “Protocol” is “Panasonic/i-PRO” or “ONVIF” during camera registration.
-

1. Select “Camera Function Settings”.

2. Select a network camera to be set from “Camera Name”.

3. Select “Execute” for “Camera Info. Display/Clock Settings”.

Note

- The following settings are possible when “Protocol” of the registered camera is “Panasonic/i-PRO”.
 - Camera Information Display
 - Time Display
 - Display Position
-

5-7. Setting Quality of Transmission Video Images

Set the quality of video images transmitted from the network cameras.

Note

- This product supports H.265, H.264, and MPEG (only cameras that support ONVIF Profile S) video compression formats.

Attention

- When devices such as recorders are connected to a network camera, the display and recording of such devices may be affected.
- This can be set only when “Protocol” is set to “Panasonic/i-PRO”, “AXIS”, or “ONVIF”.

1. Select “Camera Function Settings”.

2. Select a network camera to be set from “Camera Name”.

3. Set the following items under “Video Settings”.

Protocol			Item	Detail	Setting range
Panasonic/ i-PRO	AXIS	ONVIF ^{*7}			
		√ ^{*3}	Media Type	Displays the media type (Media1 or Media2).	-
		√	Media Profile	Select the profile.	EIZO_Profile / Profile of each camera
		√	Encoder	Select the encoder settings.	According to the camera specifications
√ ^{*3}	√	√ ^{*8}	Compression Format	Select the compression format.	H.264 / H.265 / MJPEG ^{*9}
√ ^{*3}	√	√	Resolution	Set the resolution.	According to the camera specifications
√ ^{*4}	√	√	Frame Rate	Set the frame rate (video image update interval).	According to the camera specifications
		√	Encoding Interval	Set the encoder interval.	According to the camera specifications
√	√	√	Bit Rate (Max.)	Set the maximum bit rate.	0 to 8192 kbps
		√	Video Quality	Set the image quality. The higher the value, the higher the image quality.	According to the camera specifications
		√	GOV Length ^{*1}	Set the I-frame interval.	According to the camera specifications
		√	H.264 Profile ^{*1}	Select a H.264 standard profile.	Baseline / Main / Extended / High
√ ^{*3}	√ ^{*3}	√ ^{*3}	Comm. Method	The communication methods for camera video images are displayed.	RTP over UDP / RTP over RTSP / SRTP over UDP
√ ^{*3}	√	√	Transmission Mode	Select the transmission mode.	Unicast / Multicast
√ ^{*3}	√	√ ^{*2}	Multicast Address ^{*2}	Set the Multicast address for Multicast transmission.	224.0.0.0 to 239.255.255.255
√ ^{*3}	√	√ ^{*2}	Multicast Port ^{*2}	Set the Multicast port number for Multicast transmission.	1824 to 65534: even numbers only
√ ^{*3}	√	√ ^{*2}	Multicast TTL ^{*2}	Set the network TTL value for Multicast transmission.	According to the camera specifications
√			Refresh Interval	Set the refresh interval (I-frame interval) of images.	0.2 to 5 seconds

Protocol			Item	Detail	Setting range
Panasonic/ i-PRO	AXIS	ONVIF ^{*7}			
√			Transmission Priority	Set the video bit rate transmission priority.	Constant Bit Rate / Frame Rate / Best Effort
√ ^{*5}			Bit Rate (Min.)	Set the minimum bit rate for the video to be transferred.	0 to 8192 kbps
√ ^{*6}			Image Quality	Set the image quality for the video to be transferred.	Fine (prioritize image quality) / Normal / Low (prioritize motion)
	√		Video Stream	Select the display mode to be used by the camera display.	According to the camera specifications
	√		Stream Profile	Select the profile that the camera has.	EIZO_Profile / Profile of each camera
	√ ^{*3}		Rotation	Select the rotation direction of the images.	0 / 90 / 180 / 270
	√ ^{*3}		GOP Length ^{*1}	Select the GOP length for the video.	According to the camera specifications
	√		Priority ^{*1}	Sets the priority for video compression.	None / Frame Rate / Quality

*1 Displayed when "H.264" is selected for "Compression Format".

*2 Displayed when "Multicast" is selected for "Transmission Mode".

*3 Read Only

*4 Can only be adjusted when "Transmission Priority" is "Frame Rate"

*5 Can only be adjusted when "Transmission Priority" is "Best Effort"

*6 Can only be adjusted when "Transmission Priority" is other than "Frame Rate"

*7 If "Media Type" is set to "Media2", all items are read-only, and you cannot change the settings.

*8 If "Media Type" is set to "Media1", you can set it to "H.264" or "MJPEG". If "Media Type" is set to "Media2", you can set it to "H.265" or "H.264".

*9 This can be set only when "Protocol" is set to "ONVIF".

Note

- If "Protocol" is set to "DirectUri," "SRT," "EIZO Streaming Gateway," or "Qognify", the settings are displayed.
- The following settings are possible in "Other" when "Protocol" is "Panasonic/i-PRO" during camera registration.
 - Pan/Tilt-flip
 - Upside-down
 - Lamp Display

4. Select "Apply".

Attention

- Depending on the network camera, some set values may not be reflected. Check the specifications of the camera.
- When changes are made to image quality settings such as resolution, the image quality of other recording devices and display devices using the same "Encoder" may be affected. Check the impact of changes to the image quality settings in advance.

5-8. Registering the Network Camera Preset Position

Attention

- The following settings are only possible on the monitor console and when “Protocol” is set to “ONVIF” during camera registration.

1. Select “Camera Function Settings”.

2. Select a network camera to configure from “Camera Name”.

3. Set the following items under “Preset”.

Item	Description	Range
Preset	Select a preset.	Not Selected / New / Registered Presets ^{*1} / HOME
Preset Name	Sets the preset name.	Unicode (up to 255 characters) ^{*2}
Brightness	Adjusts the network camera brightness.	-
Focus	Adjusts the network camera focus.	-
PTZ Adjust	Adjusts the display magnification, horizontal position (pan), vertical position (tilt), and PTZ operation quantity of the network camera.	-

*1 Displays when there are registered presets.

*2 Depending on the camera specifications, it may not be possible to register presets even if the conditions have been met.

4. Click “Register”.

Note

- Click “Delete” to delete the settings of the selected registered preset.

Chapter 6 Live Image Screen Settings

In the live image screen settings, display settings such as changing the live image screen layout are performed.

6-1. Setting Display Positions of Camera Video Images

Set the display position for video images from the network camera.

You can switch the display positions of the source and destination camera images by dragging and dropping the camera name.

1. Select “Display Position Settings” of “Display”.

The “Display Position Settings” screen is displayed.

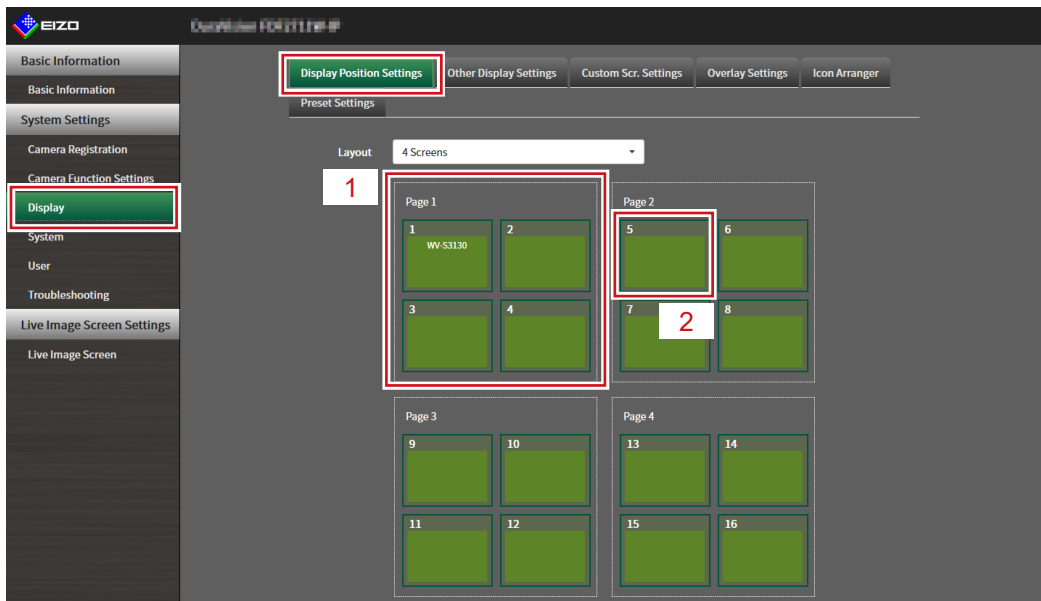

No.	Description
1	A group of cameras displayed at the same time in the video image display area.
2	The position of a camera displayed in the video image display area. The registered camera name is displayed.

2. Select the layout of the live image screen.

When a layout is selected, the display on the page changes to the selected state. You can set the display status while imaging.

3. Select the name of the camera to move, and drag and drop the name on the position of the destination camera name.

The display positions of the source and destination camera video image are switched.

Example: 4-screen layout

1. Select “Display Position 1” for page 1.

2. Drag and drop it at “Display Position 5” on page 2.

The “Display Position 1” camera and “Display Position 5” camera are switched.

Only the camera name in the inner square is moved. The display position of the camera video image does not move.

4. Select “Apply”.

The display positions of camera video images are updated. When “Reset” is selected, the information of the setting being changed is discarded and the setting is reset to the current display setting of the product.

Note

- If displayed on the web browser screen, a camera web page link is embedded in the frame where a camera name is assigned (Excluding if Protocol of the network camera is set to “DirectUri” or “SRT”). Click the camera name, and a camera web page is displayed in a separate window.
-

6-2. Setting Display Methods of Camera Video Images

Set whether to display/hide the camera name displayed on the live screen, the screen switching interval, aspect ratio, and whether to display/hide the “Not Registered” message.

1. Select “Other Display Settings” of “Display”.

2. Set the following items.

Item	Detail	Setting range
Camera Name Display	Select to display or hide the registered camera name on the live image screen.	On / Off
Size	Set the font size.	Large / Medium / Small
Color	Set the text color.	White / Black
Border	Set whether or not to add outlines to text.	On / Off
Background	Set whether or not to add a semi-transparent background for text.	On / Off
Position	Set the text display position.	Upper left / Upper right / Lower left / Lower right
Sequence Interval	Set the interval for changing over the screen during sequential display.	5 to 60 seconds
Aspect Ratio Mode	Set which aspect ratio to apply when the aspect ratio of the video image delivered from the network camera is different from the aspect ratio displayed in the image display area on the monitor. If “Aspect” is selected when “Custom Screen” is selected for “Layout”, either “Full” or “Aspect” can be selected for each camera video image. For details, refer to “6-3. Setting Custom Screen Layouts” (page 63) .	Full / Aspect
“Not Registered” Display	Set whether to display/hide the “Not Registered” message when no camera is registered.	On / Off

3. Select “Apply”.

6-3. Setting Custom Screen Layouts

Set the display layout when “Custom Screen” is selected in “Layout” for the Live Image Screen.

1. Select “Custom Scr. Settings” of “Display”.

The “Custom Scr. Settings” screen is displayed.

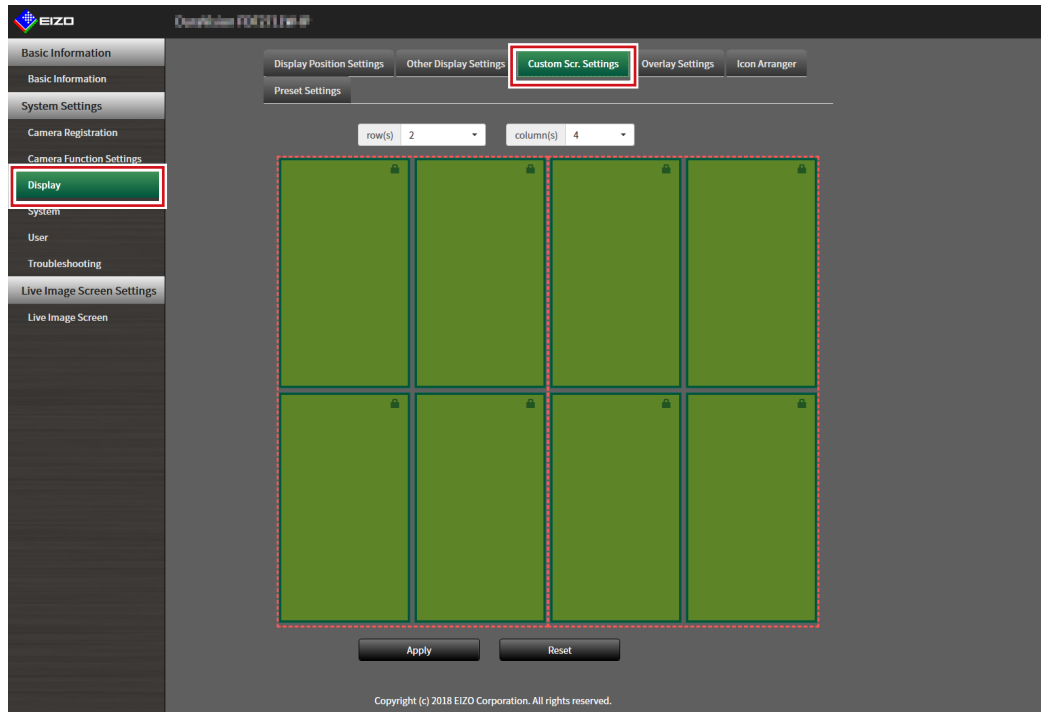

Note

- When set to “Extended” in “Multi-Monitor”, the range displayed on each monitor is shown as a red, dotted line.
- Click  in the display position frame to fix the display position of any camera image. The display position for the specified camera image is maintained even if the pages are switched. This function can only be used with “Custom Scr. Settings”.

2. Select the number of “row(s)” and “column(s)” from the list box.

The screen will change to a layout with the selected number of columns and rows.

3. Drag a camera image display position and drop it on the display position you want to couple with.

The selected display position is coupled.

4. Select “Apply”.

The display position coupling is updated. When “Reset” is selected, the information of the setting being changed is discarded and the setting is reset to the current display setting of the product.

Note

- To release the coupling, click the display position just coupled. This can also be performed by changing the number of columns and rows from the list box.
- If “Aspect Ratio Mode” is set to “Aspect”, “Full” or “Aspect” is displayed for the camera display position, and the setting changes every time either one of them is selected. For information on setting “Aspect Ratio Mode”, see [“6-1. Setting Display Positions of Camera Video Images” \(page 60\)](#).

6-4. Changing the Displayed Layout Icon

Enterprise license

You can change the icons to be displayed on the display menu on the live image screen.

1. Select “Icon Arranger” in “Display”.



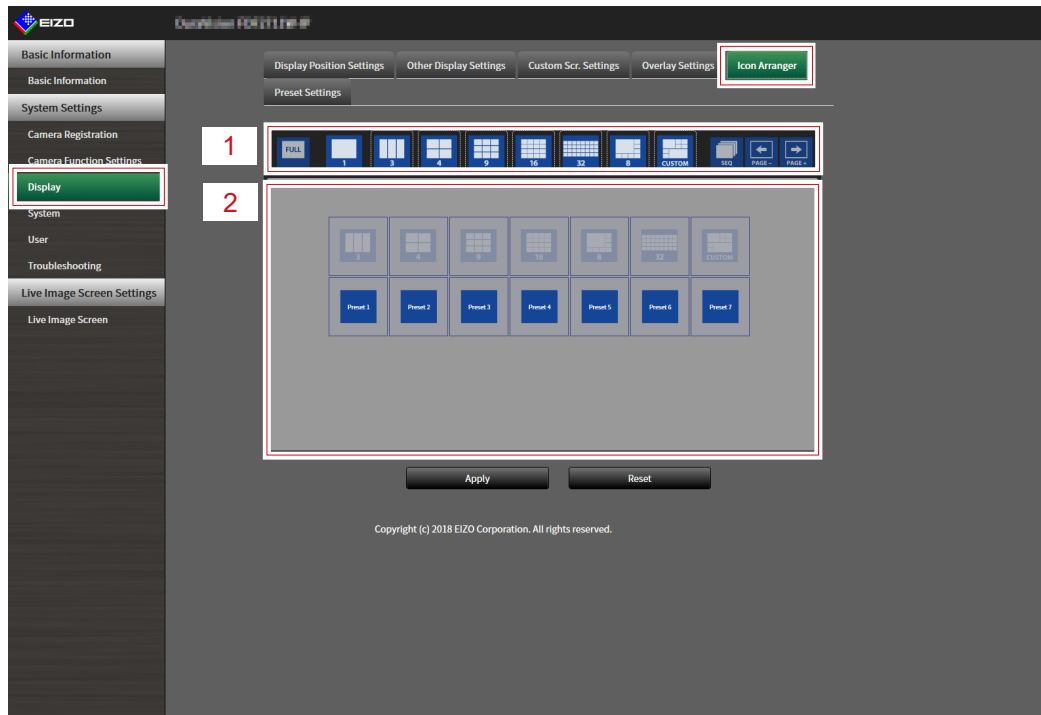

The “Icon Arranger” screen is displayed.



No.	Description
1	Icon Registration Area
2	Icon Selection Area

2. Drag the icon you wish to change and drop it in the icon registration area where you wish to display it.

Note

- If another icon is already registered at the destination, the position of the icons will switch.
- If you wish to delete an icon from the display menu, drag and drop the icon from the icon registration area to the icon selection area.
- Cannot change     

3. Select “Apply”.

6-5. Setting Layout Presets

Enterprise license

You can save the live image screen display layout and camera location as presets.

NOTE

- Up to seven presets can be saved.
-

- 1. Select “Preset Settings” in “Display”.**
- 2. Select a preset number for configuration from “Preset Number”.**
- 3. Set the preset name in “Preset Name” in the “Basic Settings” tab.**

Item	Description	Range
Preset name	Enter the preset name. To enter characters other than alphanumeric characters and symbols, use the web console.	Any character (up to 16 characters)

- 4. Select the number of “Row(s)” or “Column(s)” from the list box.**

The screen will change to a layout with the selected number of columns and rows.

- 5. Select the camera image display position and drag and drop it on the display position you want to couple with.**

The selected display position is coupled.

Note

- Click the coupled display position to deactivate it. Or, change the row(s) and column(s) in the list box.
-

- 6. Select “Apply”.**

7. Select the “Camera Selection” tab.

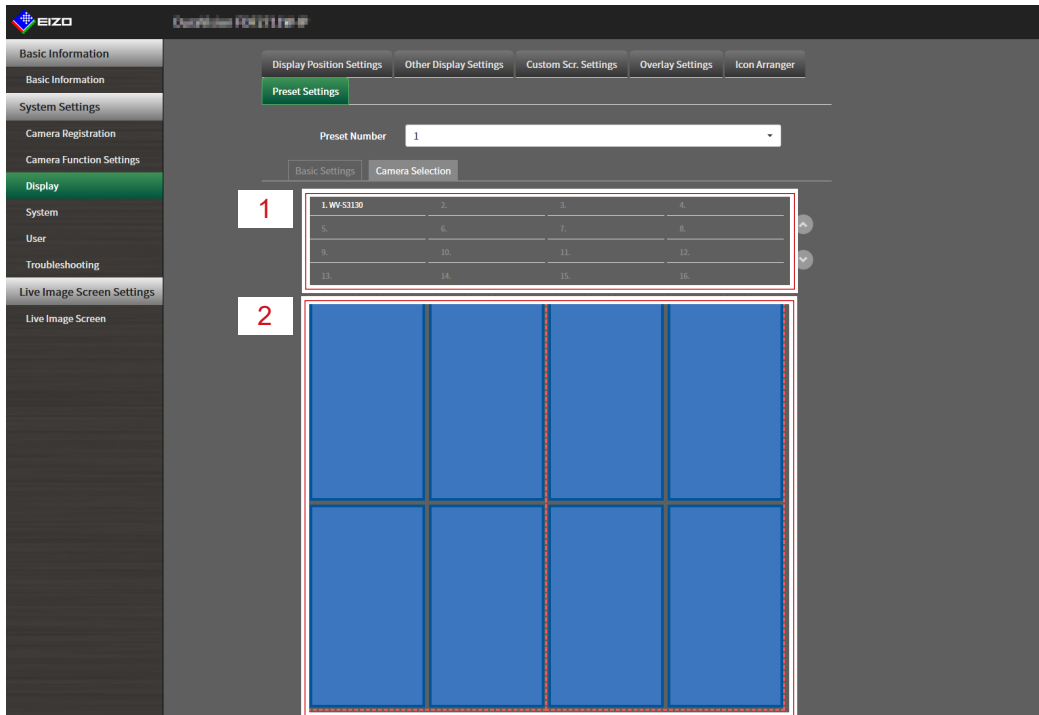

No.	Description
1	Camera Selection Area
2	Camera Location Area

8. Drag a camera to be set from the camera selection area or camera location area and drop it in the desired location in the camera location area.

Note

- Click a camera to be set from the camera selection area to put it in an open position in the camera location area.
- If another camera is already registered at the destination, the position of the cameras will switch.
- To deactivate a setting, drag and drop it from the camera location area to the camera selection area.

9. Select “Apply”.

6-6. Setting the Overlay

It is possible to display privacy masks or virtual lines on camera images on the live image screen.

1. Select “Overlay Settings” in “Display”.

2. Select a network camera to be set from “Camera Name”.

The camera settings screen of the selected network camera is displayed.

Note

- Check “Show grid” to display a grid on the camera images in the live image screen. This function can be set only when displayed on the web browser.
- Network camera images are displayed in the drawing area on the application screen.
- If the streaming gateway function is set to “Relay mode” in “Streaming mode”, any changes made to this setting will not be reflected in the system.

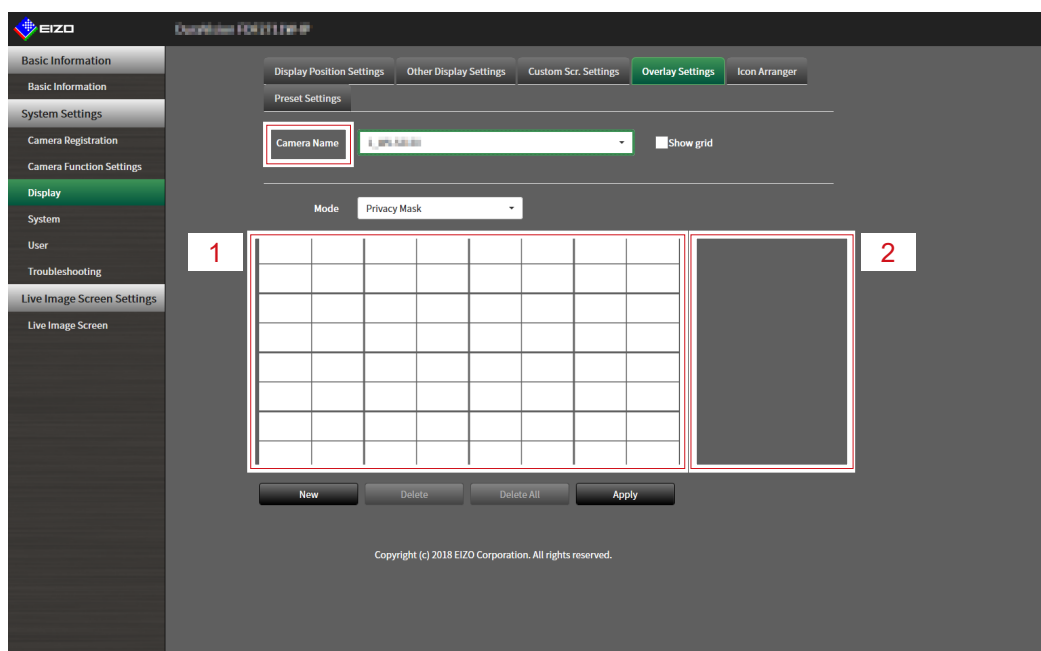

No.	Description
1	Drawing area
2	List area

3. Select an overlay type to be set from “Mode”.

Item	Description
Privacy mask	Up to 10 privacy masks can be set. Designates 3 or 4 points in the drawing area and draws polygonal shaped privacy masks.
Virtual line	Up to 10 virtual lines can be set. Designates 2-10 points in the drawing area and draws virtual lines.

4. Select “New”.

A new overlay type is added to the list area.

5. Set the overlay items

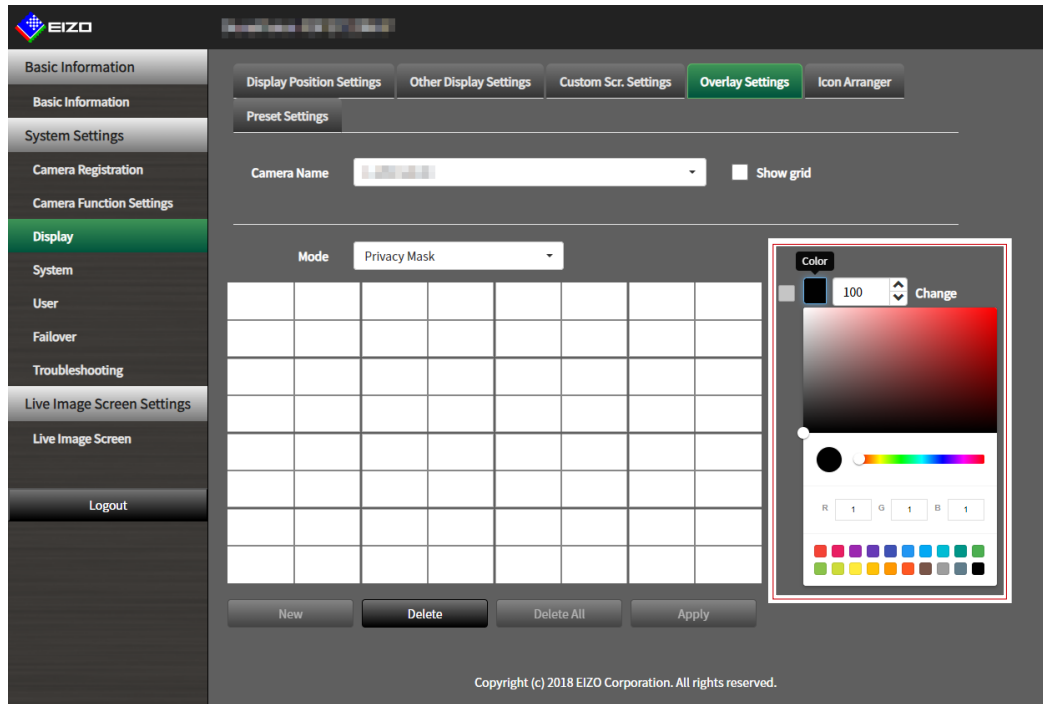

Item	Description	Range
Check box	Switches between displaying/hiding the overlay.	-
Color	Select a color from the color palette.	-
Opacity ^{*1}	Select opacity.	0 to 100
Weight ^{*2}	Select line weight	1 to 12

*1 Privacy mask only item.

*2 Virtual line only item.

6. Draw the overlay in the drawing area.

7. Select “Apply”.

The overlay is displayed in the drawing area.

Note

- Specific overlays can be deleted by following the steps below.
 1. In the drawing area, select the overlay you wish to delete.
“Selected” will be displayed on the selected overlay items in the list area.
 2. Select “Delete”.
 3. Select “Apply”.
- Select “Delete All” to delete all overlays..

6-7. Setting the Display Methods of Live Image Screens

Display settings such as changing the live image screen layout are performed.

1. Select “Live Image Screen Settings” of “Live Image Screen”.
2. Select each setting item from the list box.

Item	Detail	Setting range
Full Screen Display	Set to display or hide the menu on the live image screen.	On / Off
Layout	Set the layout to be displayed on the live image screen.	1 Screen / 3 Screens / 4 Screens / 9 Screens / 16 Screens / 32 Screens / 8 Screens / Custom Screen
Page	Set to switch the page of camera video images to display on the monitor.	1 to 48
Sequence	Set to switch the page sequence display on or off.	On / Off

3. Select “Apply”.

6-8. Setting Current Monitor Display Status

1. Select “System Status Settings” of “Live Image Screen”.
2. Set the following items.

Item	Detail	Setting range
Current Status Only for the web console	<p>Selects the status.</p> <ul style="list-style-type: none"> • Live Image Screen The monitor screen is displaying the Live Image Screen • Quick Shutdown The power is off • Setting Screen The monitor screen is displaying the Setting Screen <p>Attention</p> <ul style="list-style-type: none"> • It is not possible to change “Current Status” to “Setting Screen”. It is possible to change to other statuses from the “Setting Screen”. 	Live Image Screen / Quick Shutdown / Setting Screen
Camera Mode Enterprise license Failover extended functionality license Only for the web console	<p>Select “Failover Settings” to view the cameras configured for failover.</p> <p>Note</p> <ul style="list-style-type: none"> • The setting is enabled when the failover function is enabled and “Current Status” is “Live Image Screen”. 	Standard / Failover
Brightness* ¹	Adjusts the brightness of the monitor screen.	0 to 100
Volume* ¹	Adjusts the volume.	0 to 30
Refresh Status	Gets the current status of the monitor.	-

*¹ This setting applies only to FDF2712W-IP / FDF2312W-IP.

6-9. Checking Livestream View

Enterprise license

Only for the web console

The current live image screen display can be checked by video from the web browser.

Attention

- This function can be used by up to two users simultaneously.
- This function has a display frame rate of 1 fps.
- This function does not work if the web browser is Internet Explorer.
- If the streaming gateway function is enabled, you cannot view the live image screen using this function.

1. Select “Livestream View” on the “Live Image Screen”.

The live image screen is displayed as a video. Click “Pause” to pause the video, and “Resume” to resume the video. You can switch to full screen display by double clicking the livestream view display.

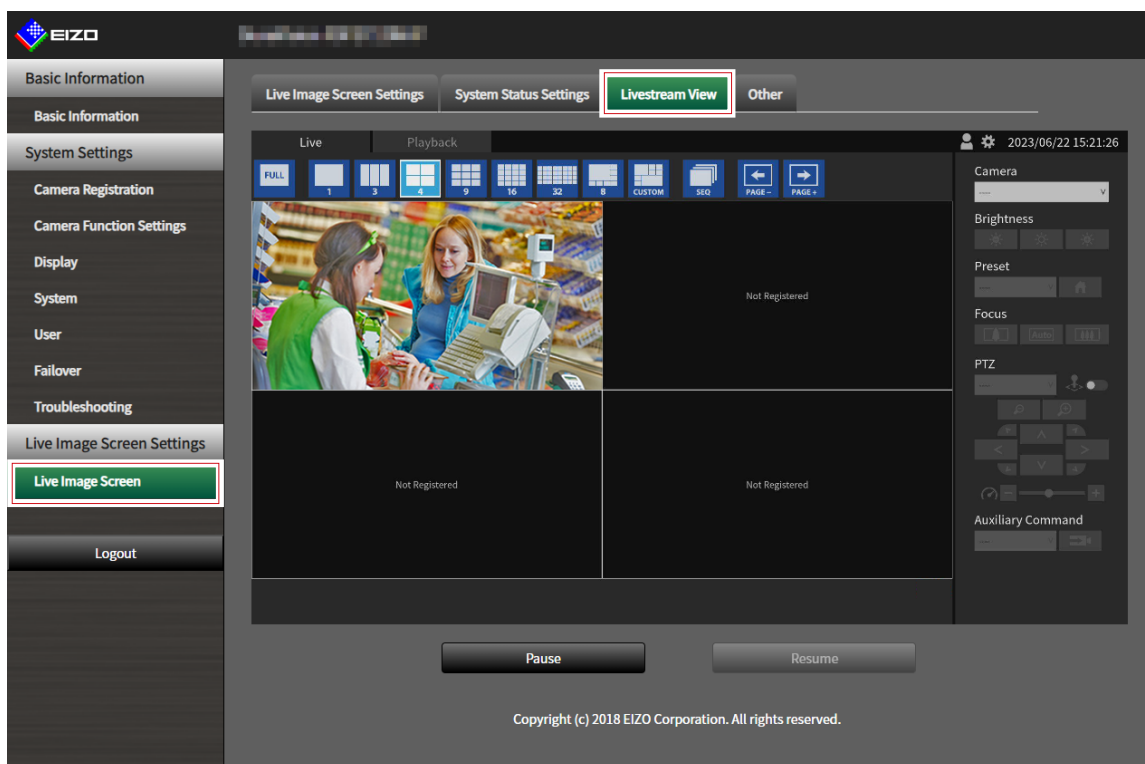

6-10. Updating the Camera Image of the Live Image Screen to the Latest Status

Only for the web console

Update the camera image of the Live Image Screen to the latest status.

1. Select “Other” on the “Live Image Screen”.

2. Select “Execute”.

6-11. Performing Advanced Settings for Camera Video

Only for the web console

Perform advanced settings for displaying camera video on the Live Image Screen. Normally, it is not necessary to change these settings.

Attention

- Changing these settings may result in camera display failure.
- If the streaming gateway function is set to “Relay mode” in “Streaming mode”, any changes made to this setting will not be reflected in the system.

1. Select “Other” for “Live Image Screen”.

2. Select each setting item from the list box.

Item	Detail	Setting range
B Frame Decode Buffer *1	When set to “On”, streams that include B frames can be displayed, but the following phenomena occur. <ul style="list-style-type: none">• Camera video display is delayed.• Video with a low frame rate such as 1 fps may not be displayed.	On / Off
Suspend While in Background *1	When set to “On”, only communication with the camera displayed on the Live Image Screen is maintained, and communication with the non-displayed cameras is disconnected each time. Communication with the cameras can be minimized, but the following phenomena occur. <ul style="list-style-type: none">• Since communication with the camera starts at the timing when the display starts, it takes time until the camera video is displayed.	On / Off
Sync Timestamp *1	When set to “On”, livestreaming is displayed according to the time stamp received from the camera. The screen stuttering of the display may improve, but the following phenomena may occur. <ul style="list-style-type: none">• Camera video display is delayed due to an increase in the buffering time.• Performance will decrease, such as decrease in the frame rate that can be displayed, due to the increased load on the CPU.	On / Off
Communication Status Display *1	When set to “On”, the data reception and network status can be checked by the color of the circle displayed in the upper right of the screen. <ul style="list-style-type: none">• Black Default status• Red Packet lost detection• Yellow No packet reception for a certain period of time• Gray Frame rate decrease due to high load• Green Normal reception of 30 frames or higher	On / Off

*1 The default setting is “Off”.

3. Select “Apply”.

Chapter 7 Management of the User Account

Perform procedures such as registering, changing, and deleting user accounts (username, user level, and password) used to access the system, and for configuring Auto Login settings.

Attention

- A maximum of ten persons can be registered for the user account. User information for a new user cannot be registered when there are already 10 users registered.
- A username that is the same as an already registered user account cannot be registered.
- It is necessary to register at least one user with a user level of "ADMIN".

7-1. Registering the User Account

1. Select "Local User" of "User".

2. Select "Add".

A dialog box for setting the user account is displayed.

Username

User Level

Password

Confirm Password

Your username must satisfy the following conditions:

- 1-16 characters
- Contain alphanumeric characters only
- May not contain the following characters: # & : " < > \

Your password must satisfy the following conditions:

- 8-16 characters
- At least one number
- At least one upper case and one lower case letter
- Contain no \ characters

OK Cancel

3. Set the user account.

Item	Description
Username	Enter a username. The username must satisfy the following conditions. <ul style="list-style-type: none"> • 8-16 characters • Contain alphanumeric characters only • May not contain the following characters: # & : " < > \ The following cannot be used in usernames: <ul style="list-style-type: none"> • " ", ". ", and "auto-login"
User Level	Select "LIVE", "CAMERA CONTROL", and "ADMIN". The operable range of this product differs by each level. For details, refer to "1-2. User level" (page 7).
Password	Specify the password. The password must satisfy the following conditions. <ul style="list-style-type: none"> • 8-16 characters • At least one number • At least one upper case and one lower case letter • Contain no \ characters
Confirm Password	Enter the same password again for confirmation.

4. Select "OK".

7-2. Changing the User Account

Attention

- This function cannot be used if “LDAP” is selected in “User Account”. For details, refer to [“7-5. Performing LDAP Settings”](#) (page 74).

1. Select “Local User” of “User”.
2. Select a user to be changed from “User List”.
3. Select “Change”.

A dialog box for entering the user information is displayed.

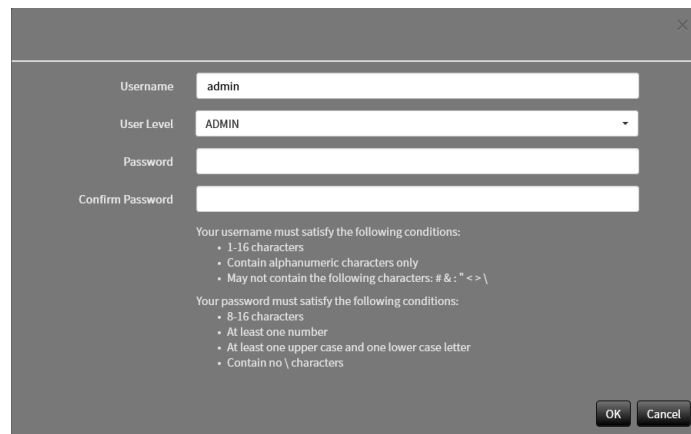

The screenshot shows a dialog box with the following fields and options:

- Username: admin
- User Level: ADMIN (dropdown menu)
- Password: (empty text box)
- Confirm Password: (empty text box)

Below the fields, there are two sets of conditions:

- Your username must satisfy the following conditions:
 - 1-16 characters
 - Contain alphanumeric characters only
 - May not contain the following characters: # & " < > \
- Your password must satisfy the following conditions:
 - 8-16 characters
 - At least one number
 - At least one upper case and one lower case letter
 - Contain no \ characters

At the bottom right, there are two buttons: OK and Cancel.

4. Change the user information.
5. Select “OK”.

7-3. Deleting the User Account

Attention

- This function cannot be used if “LDAP” is selected in “User Account”. For details, refer to [“7-5. Performing LDAP Settings”](#) (page 74).

1. Select “Local User” of “User”.
2. Select a user to be deleted from “User List”.
3. Select “Delete”.

The “Are you sure you want to delete user XXX?” confirmation dialog box is displayed.

4. Select “OK”.

7-4. Configuring Auto Login Settings

Attention

- This function cannot be used if “LDAP” is selected in “User Account”. For details, refer to [“7-5. Performing LDAP Settings”](#) (page 74).
 - Once the Auto Login settings are configured, unauthorized operation becomes easy for a malicious third party. Restrict the configuration to the application in an environment where sufficient security is ensured.
-

1. Select “Local User” of “User”.

2. Select a user to allow an Auto Login from the “Auto Login” list box.

3. Select “Apply”.

7-5. Performing LDAP Settings

Enterprise license

It is possible to log in to this product using a user account on the LDAP server when using direct service (LDAP) in User Management.

Attention

- If “User Account” is set to “LDAP”, it is not possible to login as a local user.
 - Access via web browser is only possible when the user level of the account is ADMIN.
 - It is not possible to login to this product if the LDAP settings are incorrect. For this reason, perform a login test to confirm that it is possible to login with a user account with the ADMIN user level before applying the LDAP settings.
-

1. Select “LDAP” of “User”.

2. Select “LDAP” from “Type” of “User Account”.

Note

- Checking “Allow choosing of account type on the login dialog.” enables selecting account type when logging into the product main unit.
-

3. Perform LDAP settings.

LDAP

Item	Detail	Setting range
Server Address	Enter the IP address or host name of the LDAP server.	Alphanumerics and symbols (up to 255 characters)
Port	Enter the port number.	1 to 65535*1
Base DN	Enter the identification name of the branch to search. Ex: ou=ldap,dc=example,dc=com	Alphanumerics and symbols (up to 255 characters)
Bind DN	Enter the username that has access rights to Base DN. Ex: cn=binduser,ou=ldap,dc=example,dc=com	Alphanumerics and symbols (up to 255 characters)
Bind Password	Enter the Bind DN password.	Alphanumerics and symbols (up to 255 characters)
Username Attribute	Enter the attributes of the user account to login. Ex: cn	Alphanumerics and symbols (up to 255 characters)
SSL	Insert a check when performing SSL communication (LDAPS).	-
Certificate Validation	Insert a check when performing certificate validation. Attention <ul style="list-style-type: none"> When performing certificate validation, it is necessary for the root certificate of the LDAP server to be registered in "Root Certificate" of "Certificate" of this product. 	-

*1 389 is the standard port number for LDAP, and 636 is the standard port number for LDAPS.

Search Filter Settings

Item	Detail	Setting range
ADMIN User Filter	Set the filter of the user that has ADMIN access rights. Example: (memberOf=cn=admin,ou=ldap,dc=example,dc=com)	Alphanumerics and symbols (up to 255 characters)
CAMERA CONTROL User Filter	To enable camera control access rights, enter a check to set the filter.	-
LIVE User Filter	To enable LIVE access rights, enter a check to set the filter.	-

4. Perform "Login Test".

Enter "Username" and "Password", and select "Test".

Login is executed.

5. Select "Apply".

Chapter 8 Reference

8-1. Installation of Optional Arm (FDF2712W-IP / FDF2312W-IP)

The stand of this product can be replaced by an optional arm (or optional stand). For details of supported optional arms (or optional stands), refer to our web site (www.eizoglobal.com).

Attention

- For installation, follow the User's Manual of the arm or stand.
- When using another manufacturer's arm or stand, be sure to check the following points with the manufacturer and select an arm or stand conforming to the VESA standard. For installation, use the screws that secure the stand on the main unit.
 - Intervals for screws holes on the mount: 100 mm x 100 mm
 - Thickness of the plate: 2.6 mm
 - Maximum permissible weight: strong enough to support the total weight of the monitor (without stand) and attachments such as cables.
- Use the arm or stand within the following range (of tilt angle).
 - 45° Up, 45° Down
- Connect the cables after attaching the arm or stand.
- The monitor, arm and stand are weighty. Dropping the product may result in injury or product damage.
- Regularly check the tightness of the screws. If the screws are loose, the monitor may come off, which may result in injury or equipment damage.

1. To avoid damaging the LCD panel, spread out a soft cloth on a stable surface and place the LCD panel facing down on the cloth.

2. Remove the stand.

Prepare a screwdriver separately. Use the screwdriver to remove four screws that secure the stand on the main unit.

3. Attach the monitor to the arm (or stand).

Use the screws that you have removed in the step 2.

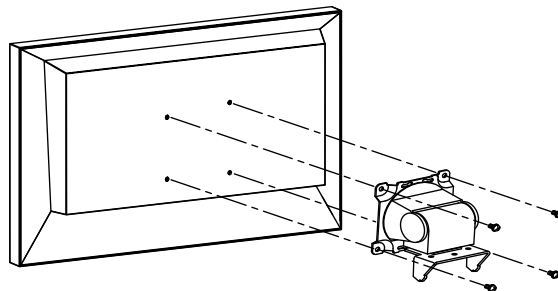

8-2. Connecting a Sub Monitor (FDF2712W-IP / FDF2312W-IP)

You can connect a monitor equipped with an HDMI[®] input terminal and use it as a sub monitor (duplicate or extended display).

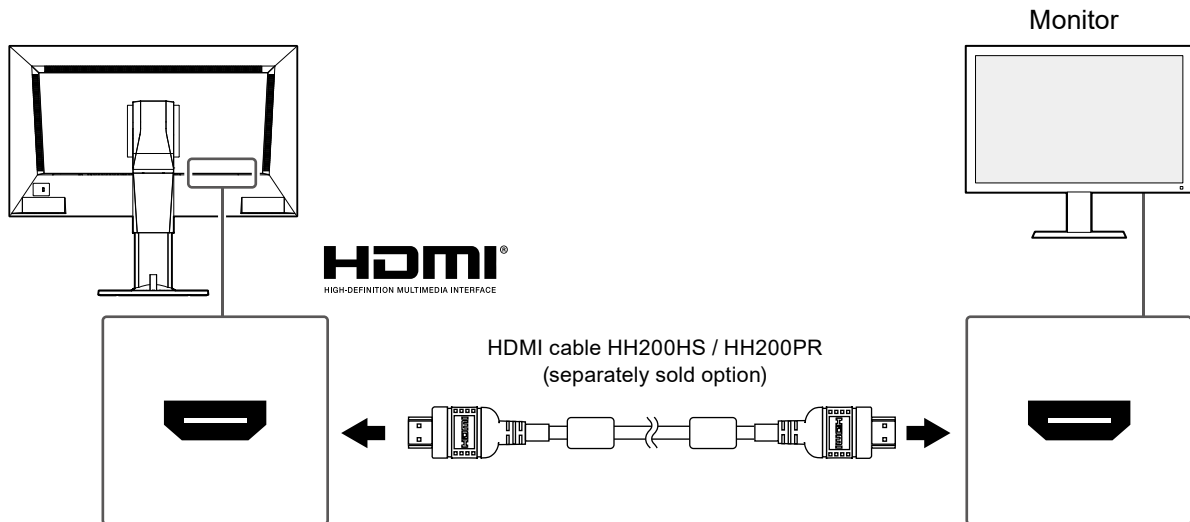

8-3. Specifications

● FDF2712W-IP

LCD panel	Type	VA	
	Backlight	LED	
	Size	27.0 inch (69 cm)	
	Resolution	1920 dots × 1080 lines	
	Viewable image size (W × H)	597.6 mm × 336.15 mm	
	Pixel pitch	0.311 mm	
	Display colors	8 bit color	16.77 million
	Viewing angles (H / V, typical)	89° / 89°	
	Contrast ratio (typical)	3000 : 1	
	Response time (typical)	Intermediate gray scale: 11 ms	
LAN	Standard	RJ-45 (1000 BASE-T, 100 BASE-TX)	
	Communication Speed	1000 Mbps, 100 Mbps	
Decoding process ^{*1}	Video compression format	H.265, H.264, MJPEG	
	Maximum resolution	H.265, H.264	3840 × 2160 ^{*2}
		MJPEG	640 × 480
	Maximum frame rate	60 fps ^{*3}	
	Maximum bit rate	8192 kbps	
	Number of displayed cameras	Max. 32 units	
	Supported Protocols	DHCP, DNS, HTTP, HTTPS, IEEE802.1X, LDAP, LDAPS, NTP, RTP, RTSP, SNMP, SRT, SRTP	
Supported streaming protocols	RTP (H.265, H.264, MJPEG, MPEG2-TS), SRT (H.265, H.264), SRTP (H.265, H.264), UDP (MPEG2-TS)		
Output signal (HDMI)	Output terminal	HDMI	
	Transmission system	TMDS (Single Link)	
USB	Port	Downstream port x 2	
	Standard	Compliant with USB Specification Revision 2.0	
	Communication speed	480 Mbps (high speed), 12 Mbps (full speed), 1.5 Mbps (low speed)	
	Power supply	Max. 500 mA / 1 port	
Audio	Speakers	1 W + 1 W	
	Output Terminals ^{*4}	HDMI × 1 (shared with video signal) Stereo mini jack × 1	
Power supply	Power supply input	100 to 240 V, 50 / 60 Hz, 0.60 A to 0.30 A	
	Maximum power consumption	59 W or less	
	Maximum power consumption in standby mode	16 W or less	
Physical specifications	Outside dimensions	640 mm × 404.5 to 554.5 mm × 245 mm (W × H × D) (tilt angle: 0°)	
	Outside dimensions (monitor)	640 mm × 379 mm × 65 mm (W × H × D)	
	Net weight	Approx. 9.9 kg or less	
	Weight (monitor)	Approx. 7.1 kg or less	
	Tilt	35° Up, -5° Down	
Operating environmental specifications	Temperature	0 °C to 40 °C	
	Humidity	20 % to 80 % R.H. (no condensation)	
	Air pressure	540 hPa to 1060 hPa	

Transportation / storage environmental specifications	Temperature	-20 °C to 60 °C
	Humidity	10 % to 90 % R.H. (no condensation)
	Air pressure	200 hPa to 1060 hPa

*1 Interlaced video streaming cannot be displayed.

*2 Images are not displayed when the maximum resolution is exceeded. Reduce the resolution and the bit rate for the network camera.

*3 The maximum frame rate differs depending on the resolution. (Refer to [“8-4. Decoding Performance”](#) (page 83))

*4 It is possible to output beep sounds when alerts are received.

● FDF2312W-IP

LCD panel	Type	IPS	
	Backlight	LED	
	Size	23.0 inch (58.4 cm)	
	Resolution	1920 dots × 1080 lines	
	Viewable image size (W × H)	509.2 mm × 286.4 mm	
	Pixel pitch	0.265 mm	
	Display colors	8 bit color	16.77 million
	Viewing angles (H / V, typical)	89° / 89°	
	Contrast ratio (typical)	1000 : 1	
	Response time (typical)	Intermediate gray scale: 8 ms	
LAN	Standard	RJ-45 (1000 BASE-T, 100 BASE-TX)	
	Communication Speed	1000 Mbps, 100 Mbps	
Decoding process ^{*1}	Video compression format	H.265, H.264, MJPEG	
	Maximum resolution	H.265, H.264	3840 × 2160 ^{*2}
		MJPEG	640 × 480
	Maximum frame rate	60 fps ^{*3}	
	Maximum bit rate	8192 kbps	
	Number of displayed cameras	Up to 16 (up to 32 if an enterprise license is registered)	
	Supported Protocols	DHCP, DNS, HTTP, HTTPS, IEEE802.1X, LDAP, LDAPS, NTP, RTP, RTSP, SNMP, SRT, SRTP	
Supported streaming protocols	RTP (H.265, H.264, MJPEG, MPEG2-TS), SRT (H.265, H.264), SRTP (H.265, H.264), UDP (MPEG2-TS)		
Output signal (HDMI)	Output terminal	HDMI	
	Transmission system	TMDS (Single Link)	
USB	Port	Downstream port x 2	
	Standard	Compliant with USB Specification Revision 2.0	
	Communication speed	480 Mbps (high speed), 12 Mbps (full speed), 1.5 Mbps (low speed)	
	Power supply	Max. 500 mA / 1 port	
Audio	Speakers	1 W + 1 W	
	Output Terminals ^{*4}	HDMI × 1 (shared with video signal) Stereo mini jack × 1	
Power supply	Power supply input	100 to 240 V, 50 / 60 Hz, 0.75 A to 0.45 A	
	Maximum power consumption	49 W or less	
	Maximum power consumption in standby mode	4.5 W or less	
Physical specifications	Outside dimensions	547.2 mm × 411.3 mm × 157.0 mm (W × H × D) (tilt angle: 0°)	
	Outside dimensions (monitor)	547.2 mm × 324.4 mm × 59.5 mm (W × H × D)	
	Net weight	Approx. 6.6 kg or less	
	Weight (monitor)	Approx. 4.2 kg or less	
	Tilt	30° Up, -0° Down	

Operating environmental specifications	Temperature	0 °C to 40 °C
	Humidity	20 % to 80 % R.H. (no condensation)
	Air pressure	540 hPa to 1060 hPa
Transportation / storage environmental specifications	Temperature	-20 °C to 60 °C
	Humidity	10 % to 90 % R.H. (no condensation)
	Air pressure	200 hPa to 1060 hPa

*1 Interlaced video streaming cannot be displayed.

*2 Images are not displayed when the maximum resolution is exceeded. Reduce the resolution and bit rate of the camera.

*3 The maximum frame rate differs depending on the resolution. (Refer to [“8-4. Decoding Performance”](#) (page 83))

*4 It is possible to output beep sounds when alerts are received.

● DX0212W-IP

LAN	Standard	RJ-45 (1000 BASE-T, 100 BASE-TX)	
	Communication speed	1000 Mbps, 100 Mbps	
Decoding process ^{*1}	Video compression format	H.265, H.264, MJPEG	
	Maximum resolution	H.265, H.264	3840 × 2160 ^{*2}
		MJPEG	640 × 480
	Maximum frame rate	60 fps ^{*3}	
	Maximum bit rate	8192 kbps	
	Number of displayed cameras	Max. 32 units	
	Supported Protocols	DHCP, DNS, HTTP, HTTPS, IEEE802.1X, LDAP, LDAPS, NTP, RTP, RTSP, SNMP, SRT, SRTP	
Supported streaming protocols	RTP (H.265, H.264, MJPEG, MPEG2-TS), SRT (H.265, H.264), SRTP (H.265, H.264), UDP (MPEG2-TS)		
Output signal (HDMI)	Output terminal	HDMI × 2	
	Transmission system	TMDS (Single Link)	
USB	Port	Downstream port × 1	
	Standard	Compliant with USB Specification Revision 2.0	
	Communication speed	480 Mbps (high speed), 12 Mbps (full speed), 1.5 Mbps (low speed)	
	Power supply	Max. 500 mA	
Audio	Output Terminals ^{*4}	HDMI × 2 (shared with video signal) Stereo mini jack × 1	
Power supply	Power supply input	12 VDC ±10 %, 2.0 A (DC input), IEEE 802.3at (PoE+ input)	
	Maximum power consumption	21.5 W or less (DC input), 25.5 W or less (PoE+ input)	
Physical specifications	Outside dimensions	165 mm × 44.2 mm × 130 mm (W × H × D)	
	Net weight	Approx. 770 g	
Operating environmental specifications	Temperature	0 °C to 40 °C	
	Humidity	20 % to 80 % R.H. (no condensation)	
	Air pressure	540 hPa to 1060 hPa	
Transportation/ storage environmental specifications	Temperature	-20 °C to 60 °C	
	Humidity	10 % to 90 % R.H. (no condensation)	
	Air pressure	200 hPa to 1060 hPa	

*1 Interlaced video streaming cannot be displayed.

*2 Images are not displayed when the maximum resolution is exceeded. Reduce the resolution and the bit rate for the network camera.

*3 The maximum frame rate differs depending on the resolution. (Refer to “8-4. Decoding Performance” (page 83))

*4 It is possible to output beep sounds when alerts are received.

8-4. Decoding Performance

Note

- Images are automatically enlarged or reduced in the product according to the resolution and layout of the monitor.
- The values are provided for reference. Videos are not displayed properly if the decoding performance is exceeded due of camera settings, network installation environment or other reasons. If videos are not displayed properly, reduce the camera resolution and bit rate. Set camera settings according to the instructions in the camera's manual.
- MJPEG can only be supported when "Protocol" is "ONVIF".

● FDF2712W-IP / FDF2312W-IP

Decoding Performance

H.265 / H.264 (when "Bit rate" is set to "4096 kbps")

1 screen layout	3840 × 2160 / 30 fps, 1920 × 1080 / 60 fps, 1280 × 720 / 60 fps
4 screen layout	3840 × 2160 / 20 fps, 1920 × 1080 / 60 fps, 1280 × 720 / 60 fps
9 screen layout	1920 × 1080 / 30 fps, 1280 × 720 / 50 fps, 640 × 480 / 60 fps
12 screen layout	1920 × 1080 / 20 fps, 1280 × 720 / 40 fps, 640 × 480 / 60 fps
16 screen layout	1920 × 1080 / 20 fps, 1280 × 720 / 30 fps, 640 × 480 / 50 fps
32 screen layout	1280 × 720 / 15 fps, 640 × 480 / 30 fps

MJPEG

640 × 480 / 30 fps

● DX0212W-IP

Decoding Performance

H.265 / H.264 (when "Bit rate" is set to "4096 kbps")

The resolution of monitor : 1920 × 1080, 60 Hz

1 screen layout	3840 × 2160 / 30 fps, 1920 × 1080 / 60 fps, 1280 × 720 / 60 fps
4 screen layout	3840 × 2160 / 20 fps, 1920 × 1080 / 60 fps, 1280 × 720 / 60 fps
9 screen layout	1920 × 1080 / 30 fps, 1280 × 720 / 50 fps, 640 × 480 / 60 fps
12 screen layout	1920 × 1080 / 20 fps, 1280 × 720 / 40 fps, 640 × 480 / 60 fps
16 screen layout	1920 × 1080 / 20 fps, 1280 × 720 / 30 fps, 640 × 480 / 50 fps
32 screen layout	1280 × 720 / 15 fps, 640 × 480 / 30 fps

The resolution of monitor : 3840 × 2160, 60 Hz

1 screen layout	3840 × 2160 / 30 fps, 1920 × 1080 / 30 fps, 1280 × 720 / 30 fps
4 screen layout	3840 × 2160 / 20 fps, 1920 × 1080 / 30 fps, 1280 × 720 / 30 fps
9 screen layout	1920 × 1080 / 25 fps, 1280 × 720 / 30 fps, 640 × 480 / 30 fps
12 screen layout	1920 × 1080 / 20 fps, 1280 × 720 / 25 fps, 640 × 480 / 30 fps
16 screen layout	1920 × 1080 / 20 fps, 1280 × 720 / 25 fps, 640 × 480 / 30 fps
32 screen layout	1280 × 720 / 15 fps, 640 × 480 / 20 fps

MJPEG

640 × 480 / 30 fps

Output resolution

The output resolutions for the video display monitor are as follows.

Resolution	Vertical scan frequency [Hz]	Dot clock [MHz]
1920 × 1080	60	594.0 (max.)
1920 × 1080	59.94	
1920 × 1080	50	
2560 × 1440	59.951	
3840 × 2160	60	
3840 × 2160	59.94	
3840 × 2160	50	
3840 × 2160	30	
3840 × 2160	29.97	
3840 × 2160	25	

Attention

- If two monitors with different resolutions are connected, the resolution will be set to the monitor connected to HDMI1.
 - When a monitor with a resolution of 3840 x 2160 is connected to HDMI1 and a monitor with a resolution of 1920 x 1080 is connected to HDMI2, a 3840 x 2160 signal is output from HDMI1, but no signal is output from HDMI2.
 - When a monitor with a resolution of 1920 x 1080 is connected to HDMI1 and a monitor with a resolution of 3840 x 2160 is connected to HDMI2, a signal of 1920 x 1080 resolution is output from both HDMI1 and HDMI2.
 - When all of the following conditions are met, the refresh rate is limited to maximum 30Hz.
 - Two monitors are connected
 - Resolution is "3840 x 2160"
 - Multi-Monitor is set to "Extended"
 - Screen Orientation is set to "Portrait"
-

8-5. Remote Control Specifications

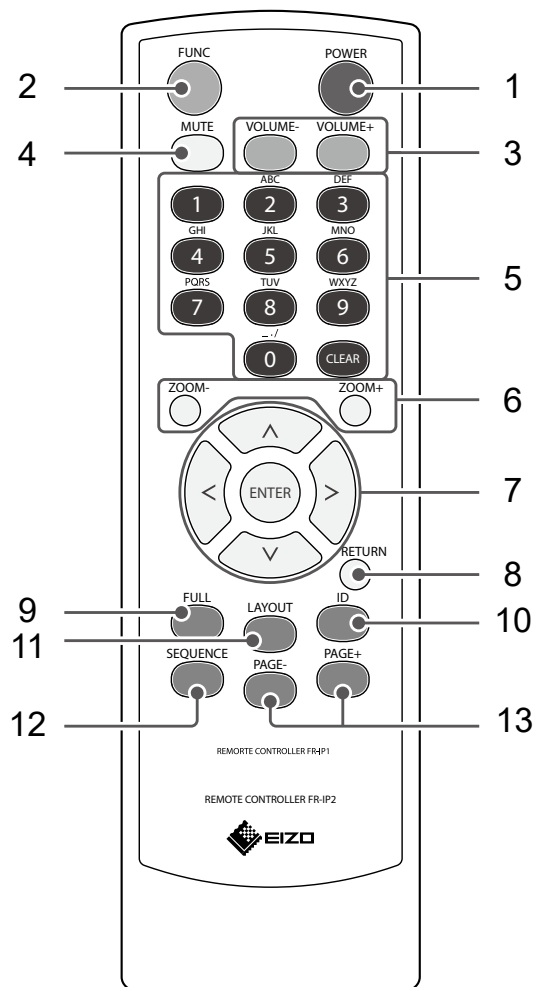

Names	Details
1. POWER	Turns the power on or off.
2. FUNC	If the camera supports pan/tilt/zoom functions, the “Zoom” button on the live image screen will be selected.
3. VOLUME- / VOLUME+	Adjusts the volume.
4. MUTE	Temporarily mutes the audio.
5. Number Buttons (0 to 9) / CLEAR	Used to enter numbers. Attention • It does not support input of characters such as alphabets.
6. ZOOM- / ZOOM+	Adjusts the camera display magnification.
7. ^ / v / < / >, ENTER	Used to move items in the live image screen and operate cameras.
8. RETURN	Returns to the previous menu status when performing a menu operation.
9. FULL	Displays/hides the menu of the live image screen.
10. ID	When the display ID setting on the remote control is on, the ID registered on the remote control and main unit is displayed on the live image screen.
11. LAYOUT	Changes the live image screen layout. Switches the layout each time when pressed.
12. SEQUENCE	Turns the sequential display of camera images on or off.
13. PAGE- / PAGE+	Changes the camera image page to display on the live image screen.

Attention

- Use the remote control within the range illustrated in the diagram below.
FDF2712W-IP / FDF2312W-IP

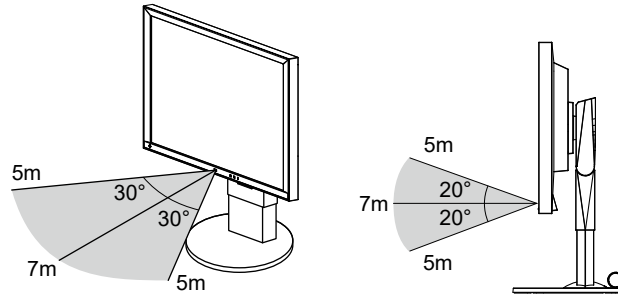

DX0212-IP

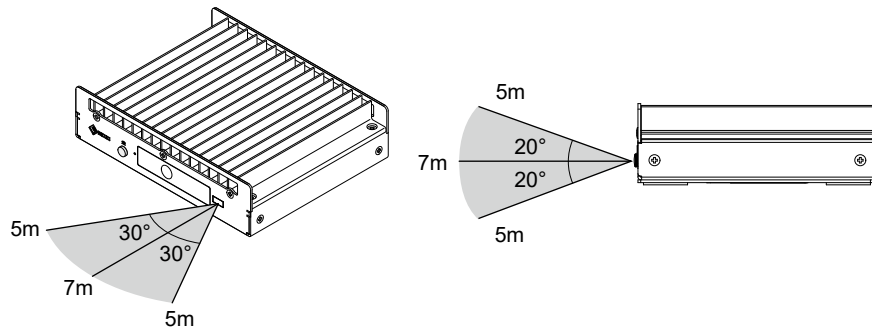

- When installing multiple units of this product, leave sufficient space between each product so that only the intended product will be operated by the remote control.
 - By setting the ID of the remote control, it is possible to operate any of the product units. With the factory values, all product units that receive the remote control signal will operate accordingly.
For information on remote control ID settings, refer to [“4-15. Setting the Remote Control ID” \(page 35\)](#).
 - You cannot operate the setting screen with the remote control.
-

8-6. CSV File Format for Camera Registration

In "Load Camera Information" (refer to "5-5. Importing Network Camera Information" (page 56)), the CSV file that can be imported must meet the following conditions.

- Comma separated CSV file
- The first row should be the header row
- All required items should be present in the header row
- The values of each item should be within the specified range
- The character code for the CSV file is UTF-8

Name in the header row	Range				
	Panasonic/i-PRO	AXIS	ONVIF	DirectUri	SRT
CameraName	(Optional) Any character (up to 100 characters)				
Protocol	Panasonic	AXIS	ONVIF ^{*1}	DirectUri	SRT ^{*2}
IPAddress	(Required) 0.0.0.1 to 255.255.255.254				
Port ^{*3}	(Required) 1 to 65535				
UserName	(Optional) Alphanumeric characters and symbols (up to 32 characters)				
PassWord	(Optional) Alphanumeric characters and symbols (up to 32 characters)				
Uri	Not required			(Required) Alphanumeric characters (up to 1023 characters)	
Comm. Method	udp	udp / rtsp / srtp ^{*4}	udp / rtsp	udp / rtsp / m2ts_udp	Not required
Enable SSL	off / on			Not required	
Certificate Validation	off / on			Not required	
Passphrase	Not required				(Optional) Alphanumeric characters and symbols (up to 79 characters)
Latency	Not required				(Required) 20 ms to 8000 ms
TransmissionMode	Not required	unicast / multicast	unicast / multicast	unicast / multicast / ssm	Not required

*1 If "Protocol" is set to "ONVIF", "Media Type" will be "Media1".

*2 If "Protocol" is set "SRT" and the "SRT" extended functionality license is not registered in this product, an error will occur when registering the camera.

*3 Typical port numbers are "80" ("443" if SSL is enabled) when "Protocol" is "Panasonic/i-PRO", "AXIS", "ONVIF", and "554" when "Protocol" is "DirectUri" and "URI" is an RTSP stream URI.

*4 If "Comm. Method" is set to "srtp", the following conditions must be met.

- An enterprise license is registered for this product
- "Protocol" is set to "AXIS"
- "SSL" is "on"

Sample CSV file

```
CameraName,Protocol,IPAddress,Port,UserName,PassWord,Uri,Comm. Method,Enable SSL,Certificate Validation,Latency,Passphrase,TransmissionMode
camera1,panasonic,192.168.0.101,80,user,pass,,udp,off,off,,
camera2,axis,192.168.0.102,80,user,pass,,srtp,on,off,,unicast
camera3,onvif,192.168.0.103,80,user,pass,,udp,off,off,,unicast
camera4,srt,192.168.0.104,5000,user,pass,srt://192.168.0.104,,off,off,125,12345678,
camera5,directUri,192.168.0.105,554,user,pass,rtsp://192.168.0.105/stream1,udp,off,off,,unicast
camera6,directUri,224.0.0.1,10002,user,pass,,m2ts_udp,off,off,,multicast
```

Appendix

Trademark

The terms HDMI, HDMI High-Definition Multimedia Interface, HDMI trade dress and the HDMI Logos are trademarks or registered trademarks of HDMI Licensing Administrator, Inc.

DisplayPort, the DisplayPort Compliance Logo and VESA are trademarks of the Video Electronics Standards Association in the United States and other countries.

The SuperSpeed USB Trident Logo is a registered trademark of USB Implementers Forum, Inc.



The SuperSpeed USB Power Delivery Trident Logos are trademarks of USB Implementers Forum, Inc.



USB Type-C and USB-C are registered trademarks of USB Implementers Forum, Inc.

DICOM is the registered trademark of the National Electrical Manufacturers Association for its standards publications relating to digital communications of medical information.

Kensington and Microsaver are registered trademarks of ACCO Brands Corporation.

Thunderbolt is a trademark of Intel Corporation in the United States and/or other countries.

Microsoft, Microsoft Edge and Windows are registered trademarks of Microsoft Corporation in the United States and other countries.

Adobe is a registered trademark of Adobe in the United States and other countries.

Apple, macOS, Mac OS, OS X, Macintosh and ColorSync are trademarks of Apple Inc.

ONVIF is a trademark of ONVIF Inc.

AXIS and VAPIX are registered trademarks of Axis AB in Sweden and other countries.

EIZO, the EIZO Logo, ColorEdge, CuratOR, DuraVision, FlexScan, FORIS, RadiCS, RadiForce, RadiNET, Raptor and ScreenManager are registered trademarks of EIZO Corporation in Japan and other countries.

ColorEdge Tablet Controller, ColorNavigator, EcoView NET, EIZO EasyPIX, EIZO Monitor Configurator, EIZO ScreenSlicer, G-Ignition, i-Sound, Quick Color Match, RadiLight, Re/Vue, SafeGuard, Screen Administrator, Screen InStyle, ScreenCleaner, SwitchLink and UniColor Pro are trademarks of EIZO Corporation.

All other company names, product names, and logos are trademarks or registered trademarks of their respective owners.

License

Some of the images in this manual are used with permission from Microsoft.

This product includes open source software.

If the open source software contains a product for which usage is granted under a GPL (GNU GENERAL PUBLIC LICENSE) license, EIZO Corporation will, in line with the GPL usage license conditions, provide the source code for corresponding GPL software via a medium, such as CD-ROM, at a cost to individuals and organizations who make contact via the following contact information for a minimum period of three years after purchase of the product.

We will also provide the source code for corresponding LGPL (GNU LESSER GENERAL PUBLIC LICENSE) software of products that include LGPL software licensed under the LGPL in the same manner as stated above.

Contact information

www.eizoglobal.com/contact/index.html

*Contact your local EIZO representative.

Except for open source software licensed under GPL, LPGL or other licenses, any transferring, copying, reverse assembly, reverse compiling or reverse engineering of any software included with this product is strictly prohibited. Further, exporting of any software included with this product in violation of applicable export laws is strictly prohibited.

This product falls within the scope of one or more claims of our patent listed in the following URL.

patentlist.hevcadvance.com

This product includes software developed by the OpenSSL Project for use in the OpenSSL Toolkit.

(<https://www.openssl.org/>)

This product includes the software written by the Independent JPEG Group.

